

CROSS ARMS

*an eastern
insulator collectors'
magazine*

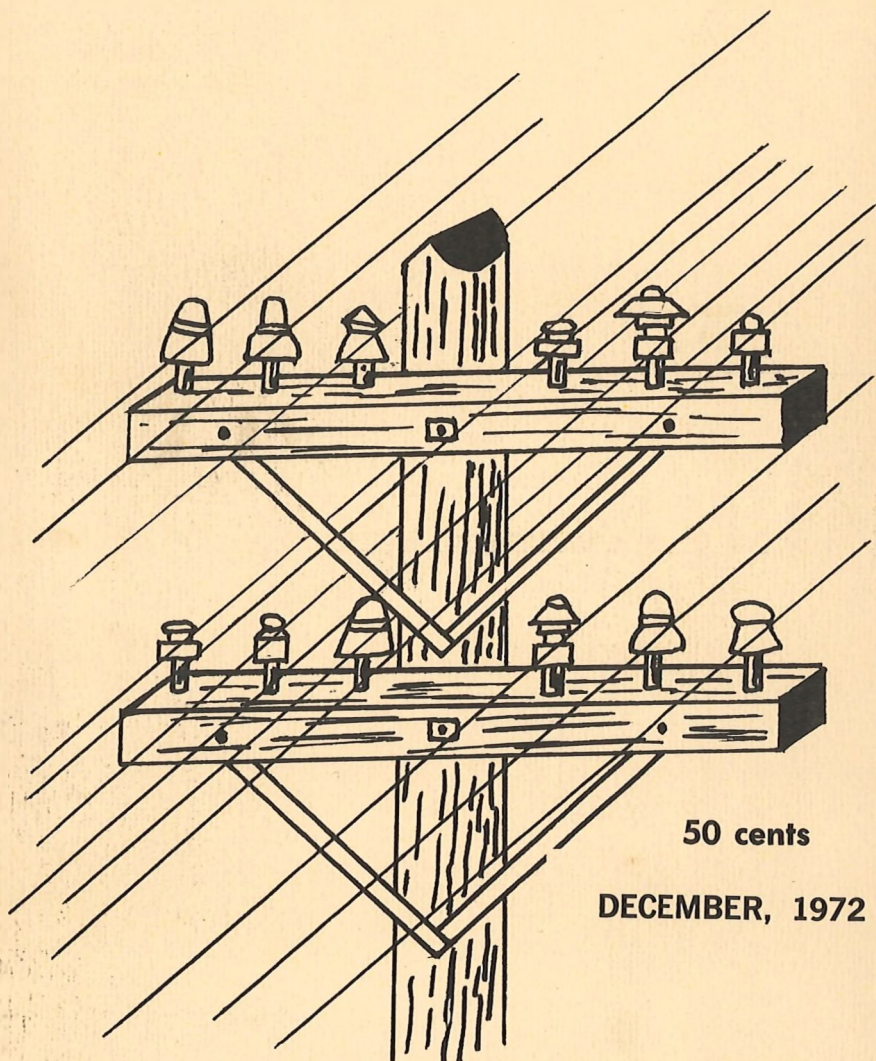

50 cents

DECEMBER, 1972

367 Signal Hill Road
King of Prussia, Pa. 19406

CROSS ARMS--dedicated to enriching the knowledge of the insulator collector, and enlarging the ranks of the insulator collecting hobby.

PUBLISHING POLICY

1. CROSS ARMS will publish any information available concerning insulator shows and swap meets.
2. Any information received by CROSS ARMS before the 15th of the month will be published and in the hands of our subscribers by the 5th of the next month.
3. All ads are kept confidential until they are published.
4. We will do our best to make sure all advertisers are reliable but cannot be held responsible for the validity of their copy nor for their performance. We accept no responsibility for errors except to reprint the incorrect portion of the ad in a later edition.
5. Send black and white prints or copies as they will reproduce with more satisfactory results. All material will be returned to the sender if specified, all other material becomes the property of CROSS ARMS.

CROSS ARMS

An Eastern Insulator
Collector's Magazine

Vol. 1, No. 11

December, 1972

Editor James Garrity
Production Catherine, Mary Alice Garrity,
Edward Szymala

Single copy 50 cents. Subscription price \$5.00 (12 issues)
Back issues available at \$.50 each. (Feb. not available)

Copyright © 1972 by CROSS ARMS

This journal is protected by copyright and no part of it
may be reproduced in any manner without written per-
mission from the publisher.

TABLE OF CONTENTS

| | PAGE |
|------------------------------------|------|
| CD of the Month (196) | 17 |
| Chicago "Jumbo" Show | 15 |
| Del-Val Bottle Show | 21 |
| Eastern Insulator Club Vienna Show | 25 |
| El Paso Insulator Show | 23 |
| Know Your Collector | 11 |
| Letters to the Editor | 27 |
| Market News | 5 |
| Patent Information | 6 |
| Shows and Swaps | 2 |
| Title Page | 1 |
| Yankee Polecat Insulator Show | 13 |

CD of the month for January is 208.

Because of the great number of shows in this issue we
have not been able to picture individual pictures of in-
sulators. We will have them in the forthcoming issues.

SHOWS AND SWAPS

This section is free of charge to anyone interested in having an announcement of their coming show published. We will be glad to print any information you would like to send to us. CROSS ARMS will furnish award ribbons to any show or swap meet that requests them. Any club or show host interested in awarding CROSS ARMS ribbons please contact us for particulars.

The guide for the calendar is as follows:

(B. S.) for bottle show.

(I. S.) for insulator show and swap.

(+) indicates more information is available on the following pages.

'73 CALENDAR

JANUARY

13, 14 (I. S.) (+) West Palm Beach, Florida.

20, 21 (B. S.) Las Vegas, NV Las Vegas Convention Cntr.

FEBRUARY

4, (I. S.) (+) Bergenfield, N.J.

MARCH

3, 4 (I. S.) (+) Lubbock, Texas.

17, 18 (I. S.) (B. S.) (+) Traverse City, Michigan.

APRIL

1 (B. S.) (I. S.) (+) Deland, Fl. see ad pg. 30.

14, 15 (I. S.) (+) Ithaca, N. Y. High School
29 (I. S.) (+) Rehoboth Beach, Del.

MAY

19 (I. S.) (+) Westerville, Ohio.

JUNE

10 (I. S.) (+) Greater Harrisburg Area, PA.

JULY

7, 8 (I. S.) Hutchinson, Kansas. Sports Arena, Fourth
National Insulator Meet.

ADDITIONAL INFORMATION

JANUARY 13 & 14

First Annual Gold Coast Insulator Meet, 501 Monceaux
Road, West Palm Beach, Florida. Contact: Charles
Glasgow, 3808 Pine Wood Ave, West Palm Beach, FL
33407 or A. W. Merrell, Jr., 501 Monceaux Road. W.
Palm Beach, Florida 33405 (305) 833-9714.

FEBRUARY 4

A show and swap well be held at Bergenfield, N.J.
Ribbons will be awarded. Tables will be \$5 per table,
\$3 for half table. Tables will be 8 foot. Contact:
Jerry Wagner, 15 N. Demarest Ave., Bergenfield,
N. J. 07621.

MARCH 3 & 4

An insulator show will be held on March 3 & 4 at the
"KOKO PALACE" on 50th Street and Avenue Q in

Lubbock, Texas by the "Hub of the Plains Insulator Club." Contact: Herman Jacobs, 2213-59th St., Lubbock, TX 79412. CROSS ARMS ribbon will be awarded.

MARCH 17 & 18

Grand Traverse Area Bottle, Insulator and Antique Show. Park Place Dome, Traverse City, Mich. Contact: Tom Ghering, 3875 Town Hall Road, Traverse City, Mich 49684.

APRIL 14 & 15

Brad & Nancy Cook will again sponsor an insulator meet at the Ithaca High School, Ithaca, NY. Contact: Brad & Nancy Cook, 507 Ridge Road, Ludlowville, NY 14862. CROSS ARMS ribbon will be awarded.

APRIL 29

First State Insulator Swap Show and Sale at Rehoboth Beach Convention Hall. 100 tables available. Opens at 6 a.m. for dealers and 9 a.m. to 5 p.m. for public. Admission free. Tables are \$8 and \$5 for 1/2 table. There will be door prizes and ribbons. CROSS ARMS ribbon will be awarded. Please have reservations in by April 15 to Charles Irons, Jr., No. 3, Elizabeth St., Milford, DE 19963.

MAY 19

The Mid-West Insulator Swap and Show will be held on May 19 in the Westerville, Ohio, Grange Hall, 15 miles northeast of Columbus, off I.S. 270. CROSS ARMS ribbon will be awarded. Contact: Don Bauman, 6706 Charles Rd., Westerville, OH 43081.

JUNE 10

First Pennsylvania Insulator Show June 10, 1973.
Greater Harrisburg, Pa Area. For more information contact: Ed & Jeannie Szymala, 217 Spruce St., Cresson, PA 16630.

MARKET NEWS

A lead insulator, same size as CD 735 skirt embossed F: U. S. TEL CO.; B-CHESTER, NY has appeared in the hands of 3 different collectors so far in the east coast. After studying it closely at the Vienna Show and conferring with several collectors at the show including Mr. Milholland we urge extreme caution be exercised concerning this piece. In our Dec. issue we will come out with a full report.

Going prices of insulators

Del-Val Bottle Show

| Manufacturer | CD | Condition | Color | Price |
|------------------|-----|-----------|-------|---------|
| NEGM | 145 | mint | aqua | \$ 2.00 |
| & | 117 | mint | green | 50.00 |
| AU | 427 | mint | aqua | 60.00 |
| Leffert's Patent | --- | mint | aqua | 50.00 |

Vienna Show

| | | | | |
|----------|-----|------|--------|--------|
| Cable | 254 | mint | green | 15.00 |
| Cable | 267 | mint | green | 150.00 |
| WGM | 121 | mint | purple | 10.00 |
| Columbia | 262 | mint | aqua | 100.00 |
| Cable | 259 | mint | varied | 8 - 15 |

PATENT INFORMATION

Merritt L. Wood, of Ithaca, New York, assignor to himself, Samuel Porter, and L. M. Monroe.

PATENT NO. 71,564, dated November 26, 1867.

The nature of my invention consists in a conical-shaped iron case, made largest at the upper end, to be applied to a wooden standard, provided with a wedge, which is forced in by the case when it is forced on to the standard to spread the end of the standard into the upper end of the case, and hold it firmly on the standard, and in making a groove around the standard that supports the case or insulator, which may be filled with paraffine or other suitable material.

The top, A, is about one and one-half inch in diameter at the top, and one-fourth of an inch smaller where it joins the base, B, which swells out somewhat in a hemispherical form to two and one-half inches in diameter. The heights of the top and base are about two inches each, making the insulator about four inches long. I make two hooks or horns, C C, on the base, just below where it joins the top, and curve the horns in towards the top, as shown in the drawing, and arrange them in such a position that they well press the wire, D, against the insulator so that the wire cannot be raised above the points of the horns without being bent considerably, so that when the wire is put in, and drawn as straight as the horns will permit, it will be held firmly by the insulator. This insulator is coated or lined with porcelain, flint, felspar, glass, or other insulating substance, on the inside, to insulate it from the standard, F, which is made of wood.

I claim in combination with the conical-shaped iron insulator, A, the wedge, H, inserted in the top of the standard or support, in the manner and for the purpose

as set forth.

I also claim the groove, N, around the standard, F, for holding paraffine or other suitable material, for the purpose set forth.

M. L. WOOD.
TELEGRAPH INSULATOR

No. 71,564.

Patented Nov. 26, 1867.

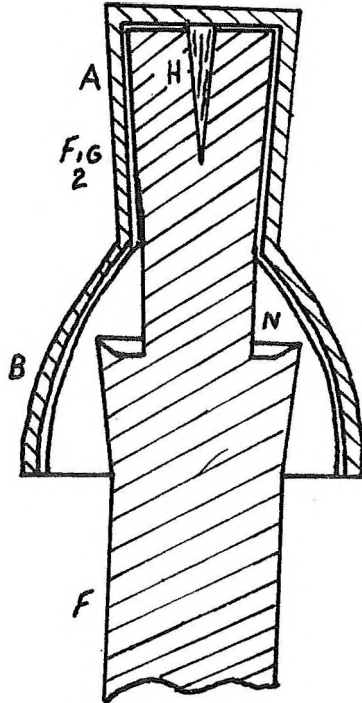
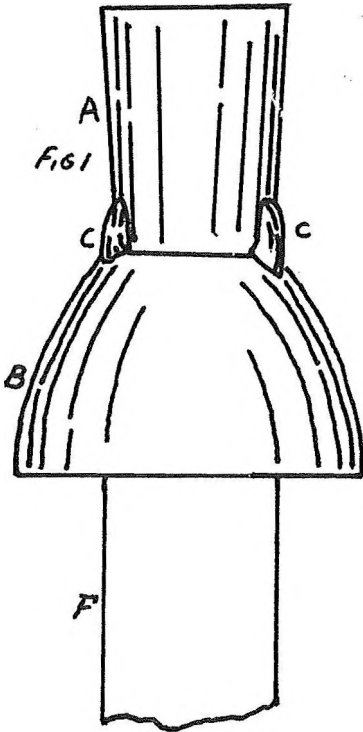

Inventor
Merritt L Wood

John F. Boynton, of Syracuse, New York.
PATENT NO. 66,453, dated July 9, 1867.

The nature of my invention and improvement consists in the insulator being made of two or more pieces, each piece being a complete insulator in itself, and the parts cemented together by an insulating material, forming a compound insulator. Heretofore, insulators have consisted of a corrugated dome-shaped glass cap, sitting upon a wooden pin inserted into the cross-arm of a telegraph pole. These glass caps are pressed in a mould, and if great care is taken in annealing them, they are brittle, liable to get out of order, and are comparatively expensive. One advantage of my insulator has over those made of glass is in the color, being black, which more readily absorbs heat, and maintaining a higher temperature, causes a more rapid evaporation of moisture from its surface, keeping the points of contact dry, and so being less liable to convey electricity from the conductor.

Figure 1 is a vertical section of an insulating cap, made in any convenient form, with a hole in the centre to receive the insulating pin, having a slot, "A", in the top, in which the conductor may rest, and a hole, "B", through which a wire passes to fasten the conductor to its place.

Figure 2 is a pin, made of non-conducting material, on which the insulating cap is placed, and cemented when desired.

"C" end of non-conducting pin, to be inserted and cemented in the insulating cap; "D", end of non-conducting pin, to be inserted into a bracket, telegraph pole, or cross-bar; "E", cement, made of insulating material,

seen in the joint between insulating pin and cap and which may be used in securing the pin to the cross-bar bracket, or telegraph pole.

The non-conducting substances which I use in making non-conducting pins, caps, and cement, for the purposes set forth, consist of a combination of hydrocarbons, sulphur, silicates, and silicic acid, as described in another application for Letters Patent, filed by me simultaneously with this one and consists of a composition of silicate of alumina, silicic acid, in the form of clay, pressed or moulded into the desired shape, and baked or burned as earthenware is burned, being left open and porous without enamel. When their temperature is about 400^o Fahrenheit I immerse them in liquid hydrocarbons.

...I do not claim an insulating cap, nor the material of which it is made; but what I do claim as my invention is---

1. Supporting an insulating cap, the whole material of which is a non-conductor, by a non-conducting pin, when such pin is constructed separately from the cap, substantially as shown and described.
2. I also claim securing a non-conducting pin to an insulating cap, both of which are composed entirely of non-conducting materials, by an insulating cement, as herein set forth..
4. I also claim the combination of a non-conducting pin, composed entirely of a non-conducting material, cemented to an insulating cap, composed entirely of a non-conducting material, with the slot A, and binding-wire hole B, substantially as herein set forth.

J. F. Boynton.

Telegraph Insulator.

Nº 66,453.

Pat. Jul. 9, 1867

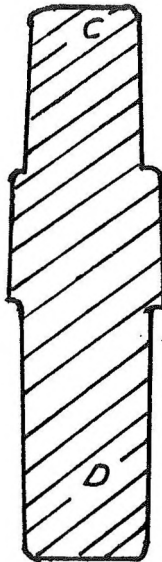
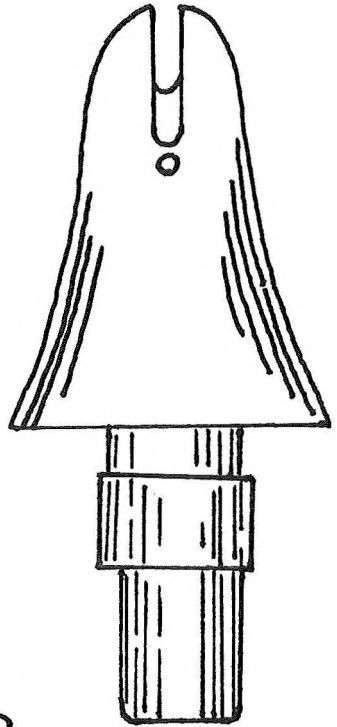
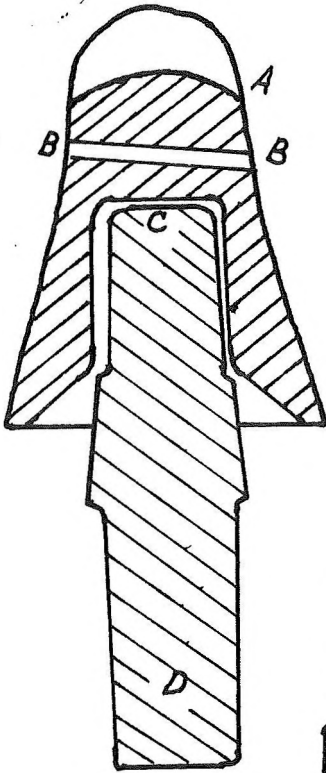

Inventor.

John F. Boynton

KNOW YOUR COLLECTOR

Collector of the month for December is Paul Simpson of Clymer, PA. Paul and his wife Diana have been collecting about 1 1/2 years and are close followers of the show and swap meets. Paul is a high school math teacher in every day life and an enthusiastic collector during his spare time. The picture below shows Paul with a segment of his collection in the background and the following page contains pictures of part of Paul's collection.

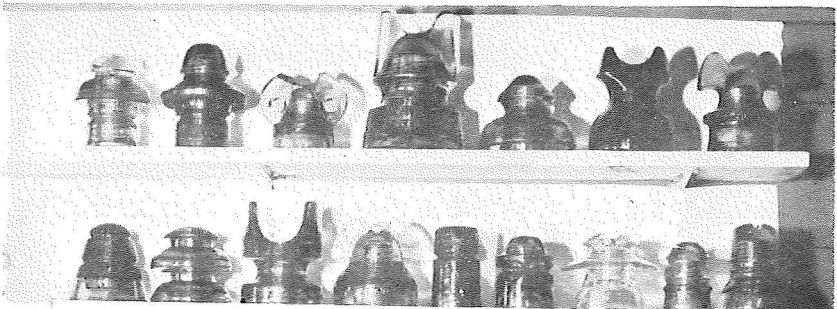

Collector of the month.



l to r: large Folembray; D-512 carnival; ★ transposition; double ◊ purple; H. G. Co #51; Calif. cross-top sca; CD 199 Knowles; 54 A&B purple; K tramp green; 66. carnival; bat ears Cable.



CD 133 BGM Co sca; CD 164 BGMCo. sca; PLW emerald green; E-14B opalescent; Chicago diamond groove; E. C. & Mco S. F. blue; & ; CD 456 Amer. Ins. Co. Sept 13, 1881, Nov. 13, 1883; sca bullet; No. 7 standard near clear; Duquesne ket; CD 460 Am Tel & Tel.

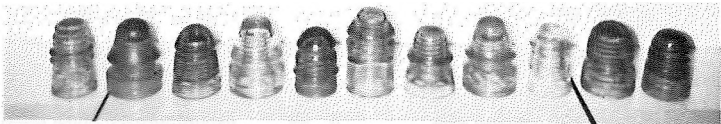

l to r: Natl Ins. Co CD 410; CD ?; CD 104 F; Brookfield-B; New York; unemb. Paisley; S. B. T & T Co. keg; Amer. Ins. Co. CD 426; OVG Co petticoat pony CD 160; Fairmount K. C. G. W. ; Westinghouse No. 4; Vertical grooves CD 143; CD 110 Brookfield spiral.

YANKEE POLECATS INSULATOR CLUB SHOW

BY Gert Wyer

On Oct. 22, the Yankee Polecats Insulator Club held a meeting and show. The show was held at Cromwell High School. We had 33 tables and many insulators changed hands with busy trading and selling. An honorary life club membership was presented to the Milhollands who were our special guests. The following awards were presented by the Club Secy. , Gert Wyer: Best quality insulator display to Allen Ward-Crown Jewels ribbon. The most unique display to Les Harris-CROSS ARMS ribbon and Randy Koopman received the junior award of the Old Bottle Magazine ribbon. Judges were Lucille Barlow, Brad Cook and El Bennett. In the afternoon Mr. Milholland spoke to the group. He reiterated on the visit the day before with Wm. Brookfield, grandson of Wm. Brookfield.

Following are pictures of the show with folks coming from the New England states as well as NY, NJ, & PA.



Les Harris receiving the CROSS ARMS award.

Yankee Polecat Show.



Randy Kooperman
receiving his
O. B. X. ribbon.

Allen Ward
receiving his
Crown
Jewels
ribbon.

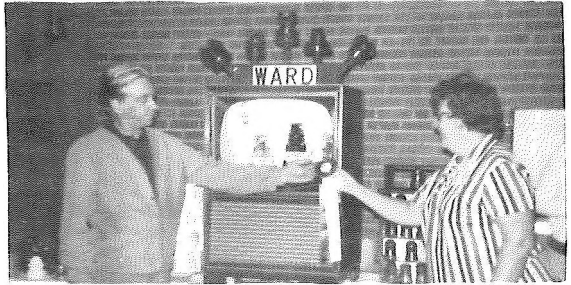

The McCombers



The Orcutt Family

FIRST ANNUAL CHICAGO MID- WEST NATIONAL INSULATOR SHOW.

Many "Jewels of the Wire" and "Jewels of the Roof-Tops" were featured at the "JUMBO SHOW" held at Kane County Fair Grounds, St. Charles, IL, Oct. 14 & 15. Many rare items were quickly exchanged in sales or trades. A few very rare (FIRST SEEN) items were quickly acquired by the most knowledgeable. Example: an amber Locke, a cobalt Locke, Miller twin pin, Wades, many threadless, Dog-ears, complete collections of AMERICANS, K. C. G. W. 's, JUMBO's, CHAMBERS, COLUMBIA's AND L. R. B. 's.

14 ribbons were awarded by the Regional Judges: Marion Milholland, Nancy Cook (NY), W. Besler (Canada), H. McCarty (MT), Bob May (IL). Our many-many sincere thanks to ALL participants, collectors and dealers at our "JUMBO SHOW". It was our GREAT PLEASURE to be Co-Sponsors for the First Chicago Mid-West National Insulator-"JUMBO SHOW."

Dick Augustyn & Larry Veneziano.



Dick Augustyn of Addison, IL one of the ribbon winners.

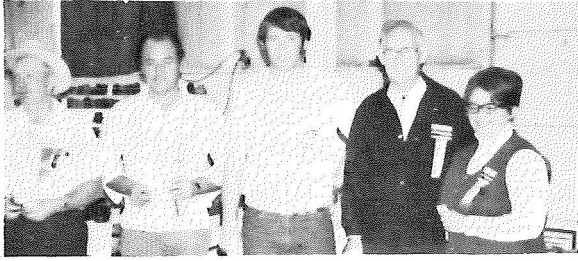

The show judges of the "Jumbo Show."

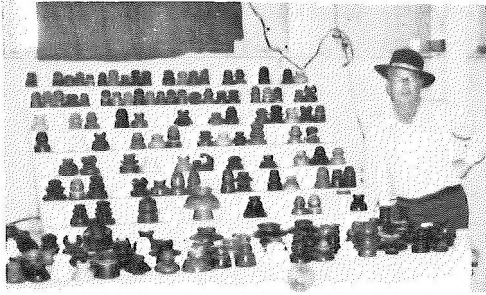

Bert Bellante of IL another ribbon winner.

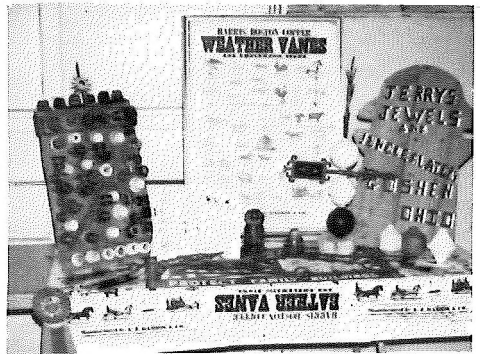

Canadian Beehives-by Tim Askew of Brighton, MI and a lightning insulator display by Jerry Turner of Goshen, OH. Jerry's display won a ribbon.

CD 196

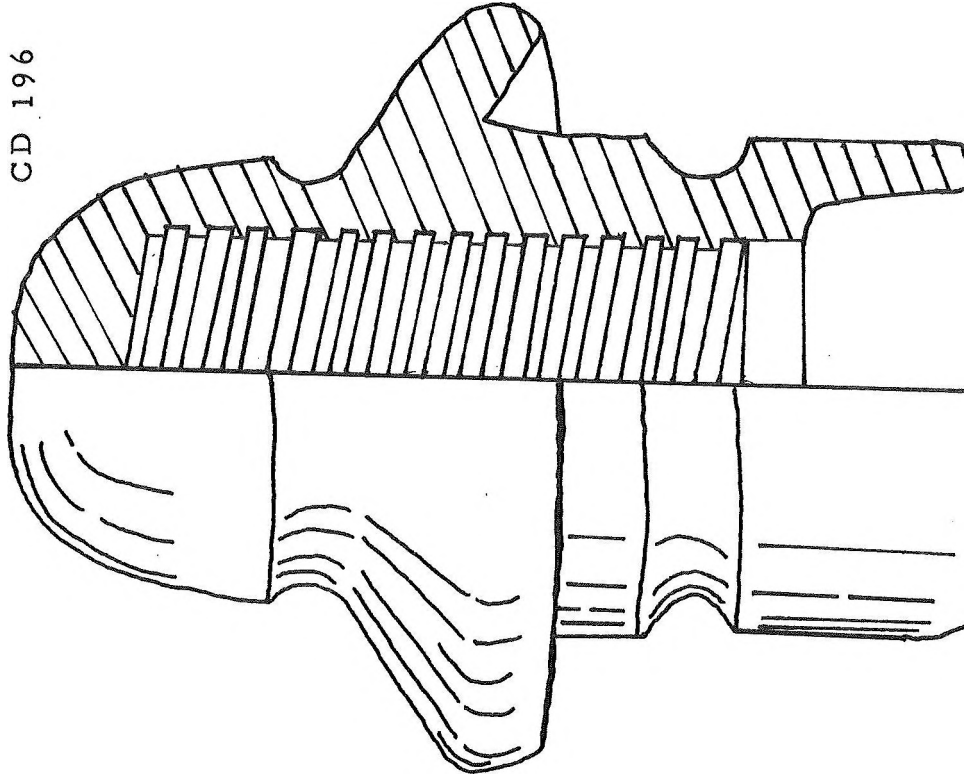

CD 196 is a one piece transposition insulator. They were used on telephone lines to cut down on cross-talk. A tramp insulator is automatically scarcer than regular insulators because of the line construction, the usual ratio is twenty single groove insulators-then a transposition. The date May 2, 1893 that appears on some CD 196's refers to patent # 496, 652 which was issued to cover the idea of drip points.

Information for CD 196 was furnished by: Marion Millholland, author of MOST ABOUT GLASS INSULATORS REVISIED; Ray Richter; Paul Simpson; Gary Hill.

LIST OF EMBOSSINGS:

Front: BB Drip points upper and lower skirts.

Front: HEMINGRAY Drip points both upper and lower skirts.

Front: on shoulder above wire groove HEMINGRAY.

Front: Skirt HEMINGRAY Drip points both skirts.

Front: H. G. CO No. 51

Back: PAT. MAY 2, 1893 Drip points both skirts.

Front: 51 H. G. CO. Drip points both skirts.

Front: H. G. CO.

Back: PAT. MAY 2, 1893 Drip points both skirts.

Front: H. G. CO.

Back: above upper skirt PATENT APPLIED FOR.

Back: lower skirt PAT. MAY 2, 1893 Drip points both skirts.

Front: Knowles prism.

Front: O. V. G. Co. Drip points both skirts.

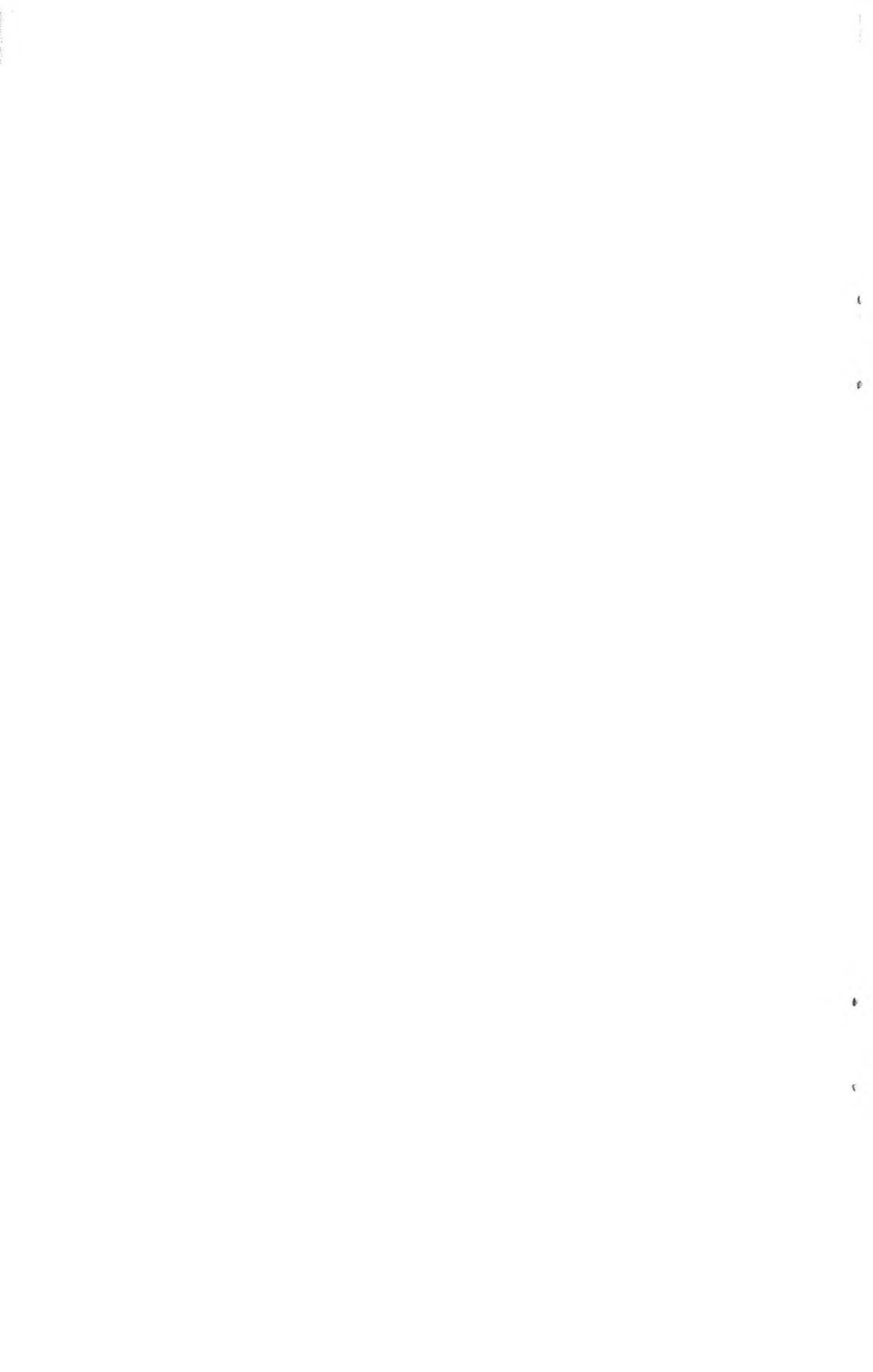

DEL-VAL BOTTLE CLUB SHOW

On Oct. 29, at the V. F. W. Lodge in Sellersville, PA, the Del-Val Bottle Club held its first bottle show and sale. 40 tables and 10 displays, of which 6 were insulator collectors, were set up. Mr. Marion Milholland and his wife attended as part of his 72-73 research trip. Paid attendance was over 1,000 and as an estimate about half were insulator collectors.



Winner of CROSS ARMS best in show: Dolph and Lucille Barlow of Buckingham, PA.

A display entitled Ambler Medicines, winner of CROSS ARMS second place, Karen Johnson of Ambler, PA.



DEL-VAL Bottle Show.



First Place
bottle display
winner: Pete
Waglam of
Chalfont, PA.

Here are some of the insulators that showed up at the Del-Val Show.

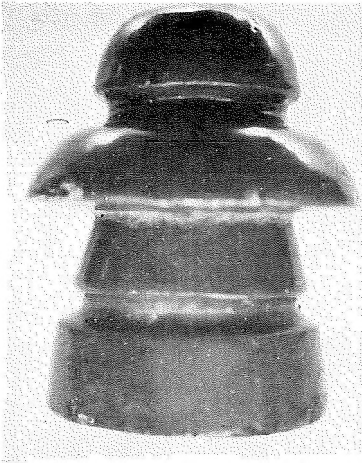

left: a no name porcelain tramp (dry process) same size as CD 200 from John Hewitt of Stockton, NJ.
right: clear Hemingray 19 CD ?? from Bill Cosner of New Hope, PA.

EL PASO'S FIRST INSULATOR SHOW

by Donna Stevens

El Paso's First Insulator Show and Swap meet was held Oct. 21-22, 1972 at the El Paso National Bank Building. The show was very small but to our way of thinking it was just great.

Crown Jewels Grand Prize ribbon and first place was won by Jerry & Donna Stevens. The CROSS ARMS ribbon which was the first place in the porcelain division along with the club's second place was won by Chester and B. J. Morris. The club's third place went to Gert Mason. Winner of the Novice class with the OBX ribbon was Jay Stevens.

Some of the pieces that highlighted the show were: Chicago Diamonds, a mint cutter a high voltage insulator from France, a threadless Brookfield, Mulford & Biddle and threadless McKee.

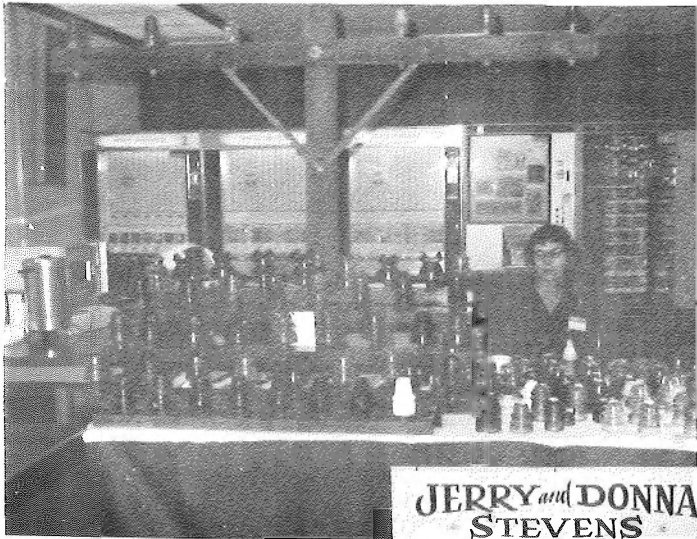

Jerry and Donna Stevens, Crown Jewels ribbon winner.

El Paso Show.



Chester and B.J. Morris, winner of 2nd place club's choice and First place CROSS ARMS ribbon (porcelain class.)

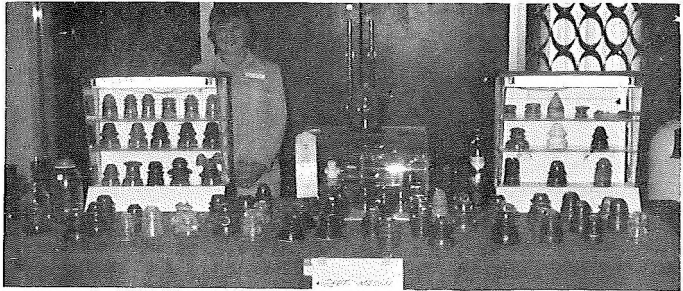

Gert Mason-third place club's choice.

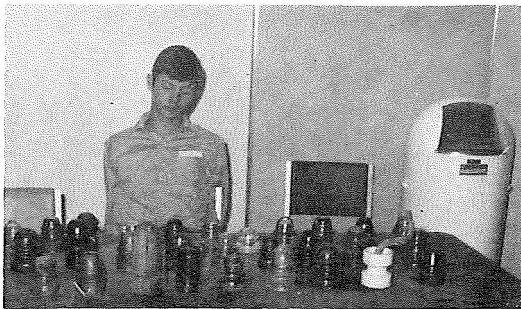

Lawrence Carpenter from Cheyenne, Wy. That's his son Ricky sitting behind the table.

EASTERN INSULATOR CLUB VIENNA SHOW

On Nov. 5, the Eastern Insulator Club held its annual fall insulator show and swap meet in Vienna, VA at the Vol. Fire Dept. 40 dealer/collectors displaying their wares and over 250 collectors attended making a generally good day all the way around. The action at the selling tables was mixed with a lot of heavy trading. Marion Milholland attended and as usual he was kept busy the entire day researching new finds and embossings.



Fred Garner of Pottstown, PA winner of CROSS ARMS "Best in Show" Advanced Glass Category.



Three nice threadless-
left: old porcelain from



Peg Hotton, Rockville, MD--middle and right: a
McMicking and CD? no name-Russell Sprague of MD.

Vienna Show.



Russell Sprague of Randallstown, MD winner of second place, advanced glass, CROSS ARMS ribbon.



Peg Hotton of MD winner of CROSS ARMS ribbon: first place-Beginners Glass.



Erik Hotton winner of the Gerald Brown book award; first place in porcelain.

LETTERS TO THE EDITOR

Dear Jim:

Just a quick note to let you know Kerr Glass Co. has run a new DP-1, CD 155, flint glass, embossed front: KERR DP1, back: MADE IN U. S. A. 72. The insulator machine does not run too often but was running when Mr. Milholland was here in Millville and he had the opportunity to again see insulators being made.

Sincerely, Don Wentzel.

* * * * *

Dear Mr. Garrity:

I have embarked on a project to make scale drawings of the "1871 Patent" insulators and to catalog the many embossings variations. At this time, I have completed 14 drawings. The enclosed Chambers is one. (see following page) Obviously, I have a long way to go. I hope that by this spring I will have sufficient number completed to send to 1871 specialists that I know for checking and comment. I have no intention to "publish another insulator book" but I am thinking about assembling the drawings into a set for those who would be interested. Any comment that you may have would be appreciated.

Sincerely, Glenn Drummond.

= = = = =

Lots of luck with your endeavor, Glenn. The patent date Dec. 9, 1871 refers to Pat. no. 122,015 issued to Robert Hemingray which deals with an improved method of forming internal threads in glass insulators. Any collector needs all the information he can get, and I'm sure that 1871 specialists welcome your collected information.

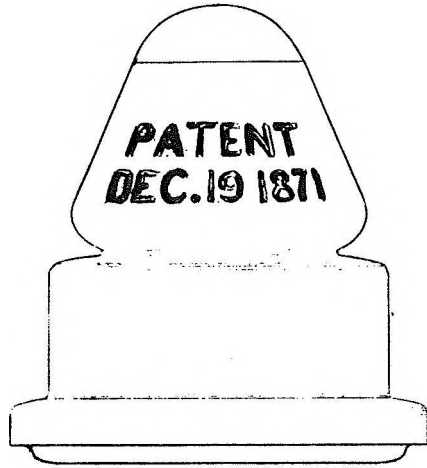

FRONT VIEW

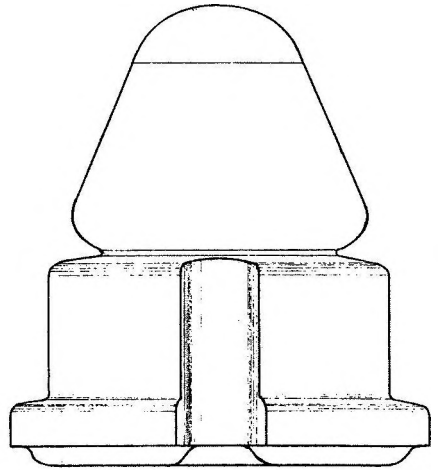

REAR VIEW

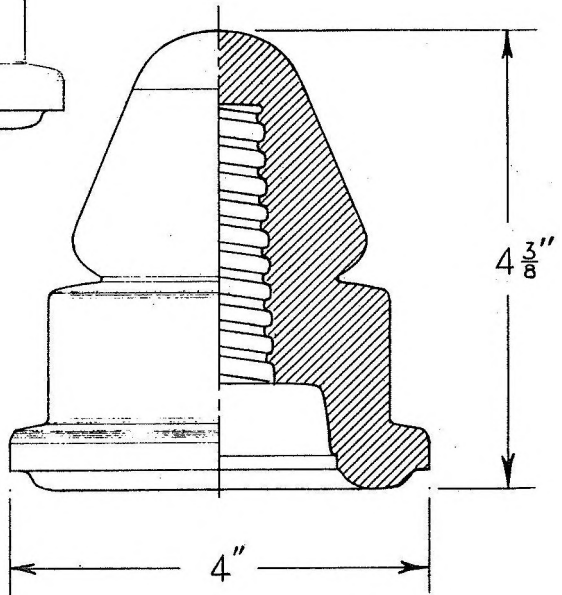

FRONT SECTION

CHAMBERS 'COMPANION'

Lightning Rod Insulator

CLASSIFIED ADS

"Latest insulator list just out." Lowest prices anywhere. 200 different to chose from. Let us put you on our mailing list if you buy! Send large S. A. S. E. to Brad & Nancy Cook, 507 Ridge Rd., Ludlowville, NY. 14862.

WILL trade 1958 Cadillac for insulators. Car in excellent condition, 44,000 miles, one driver (my Dad). Been in storage since 1968. Will trade for threadless or other rare insulators to value of \$500. Contact: R. L. Mahony, 183 Brookside Drive, Medford, NJ 08055. (609) 654-2771.

WANTED: PYREX 701 and threadless. Send SASE for new glass-porcelain list. Maury Tasem, 519 Verdin St., El Cajon, CA 92021.

INSULATOR LIST. NICE SELECTION OF COLORS and shapes. Stamped envelope plus 10¢. Phil Balkan 5860 Tobias Ave., Van Nuys, CA 91401.

JUST OUT--SECOND EDITION OF GERALD BROWN'S "COLLECTIBLE PORCELAIN INSULATORS." A completely new book--700 porcelain insulators shown and described--pricing guide. Former owners of book will receive special offer.

174 pages--8 1/2" X 11"--plastic ring binding \$6.00 PP. Gerald Brown, Two Buttes, CO 81084.

The M-T Bottle Collectors Association of Volusia County, Florida, announces their 3rd annual antique bottle and insulator festival, featuring bottles, insulators, and related collectible items.

Two big days: Saturday, March 31st and Sunday, April 1st, 1973. It will be held at the Volusia County Fairgrounds, just east of Deland, Florida, at the intersection of interstate-4 and Florida-44. There will be prizes for the 3 best sales tables voted by dealers.

6 foot tables--\$5.00 for 2 days. For information contact: M-T Bottle Coll. Assn., P.O. Box #1581, Deland, Fla. 32720 (904)734-8865.

I have for trade the following line numbers from Milhollands 1973 price list. Will adjust values depending on condition of insulators. If not happy with Milholland's Suggested Prices--make an offer. Will discount for cash deals. Will buy good and/or damaged threadless. Will trade from personal collection for threadless I need.

Line #'s 38-156-215-238-359-441-459-468-508 (No. 7 on back)-514-548-660-662-678-712-756-761-765-767-783-801-803-918-926-942-1026-1046-1099-1113-1165-1177 (clear)-1226 (nothing on back)-1230-1232-1243-1245-1257-1261-1296-1306-1346-1377-1397-1407-1416-1492-1581-1608-1653-also CD 131 no name & CD 205 Lynchburg embossed over top of Gaynor.

Bob Wilson, 21612 Chilton Road, Phila, PA 19154
(215) NE-7-9435.

I SPECIALIZE IN THREADLESS INSULATORS and will buy, sell, or trade. Send S. A. S. E. for current list of threadless types for sale, including several nice Wades priced reasonable. Dennis Rogers, 1406 N. Amador, Ontario, CA 91764.

NEW INTEREST -- Buying lightning rod balls and go withs (no plain milk glass or rounds unembossed) also all types arrows and weathervanes (animal); still paying top cash prices for rare insulators need glass Harloe, threadless, etc. Please send description and price first letter. L. Veneziano, 8310 Center St., Rivergrove, Ill 60171.

PORCELAIN INSULATORS GUIDE BOOK FOR COLLECTORS, a comprehensive original research book and complete collector's reference for unipart pin type porcelains. Universal Style Chart with scale drawings of every unipart pin type shape, manufacturer's markings, pricing guide, company histories, etc. The standard for collectors and mail traders. Hardbound, 206 pages, \$10 postpaid. Also 1972 Supplement, \$1.95 postpaid. Jack H. Tod 3427 N. 47th Place, Phoenix, Arizona 85018.

GLASS INSULATORS: Something for advanced to beginning collector. Also have list of Canadian Insulators. Send large S. A. S. E. or 10¢ for list. Howard E. Makela, P. O. Box 122, South Lansing, N. Y. 14882.

HUGE list of insulators and lightning rod balls for sale. S. A. S. E. Paul McManis, Route 1, Box 116, Excelsior, Minn. 55331.

STOLEN

My collection of the following insulators while my wife and I were attending the Insulator Show at London, Ohio on Nov. 11 and 12.

CD#

| | |
|---|-----|
| 105 or 109 in latest Milholland. CHI "Tear Drop", base | |
| CHI. INS CO PAT OCT 6, 1883 dark aqua | M |
| 110 BROOKFIELD PAT OCT 8 1907 dark aqua | M |
| 112 DUQUESNE (keg) aqua | M |
| 410 bs, NAT'L INSUL CO. 4 dates, seg. thrds. | M |
| 123 E. C. and M dark aqua | M |
| 127 W. U. PATTERN a few lines but | M |
| 130 CAL. ELEC WKS PATENT, ice aqua | M |
| 431 L. G. T. CO. PAT JAN 25, Feb 22 1870 aqua | NM |
| 432 Chambers Companion rear bs. chip | NM |
| 133 bs AM INSR CO PAT SEPT 13'81 gd. amber | VNM |
| 435 No name, (Boston Canadian) blue | NM |
| 436 ERW aqua | M |
| 138 base, NAT'L INS CO aqua | M |
| 143 SCA Withycomb horizontal ribs | NM |
| 145 T. H. -E over dome | M |
| 150 BROOKFIELD PAT OCT 8 1907 | M |
| 158 bs, BOSTON BOTTLE WKS. seg. thrds aqua | M |
| 159 GREGORY PAT APRIL 7, 1906 rear chips | G |
| 460 AM. TEL and TEL aqua | M |
| 461 bs, STANDARD INS CO BOSTON aqua | M |
| 164 K. C. G. W. PERU aqua | VNM |
| 181 "Pluto" or "Dog Ears" | M |
| 206 "Castle" light green | M |
| 257 HEM. APR JUNE 17, 1890, MAY 2, 1893 peacock | M |
| 701 "Egg" flat top, dark green (black) | NM |
| 723 Wade, emb. raised lines and dots. thumbnail ch on base otherwise mint dark aqua. | |
| 731 Arc emb. TILLOTSON aqua, sm. brownish dis- coloration in crown but | M |

| | |
|---|----|
| 732 unemb. Tillotson dark aqua, skirt ding | NM |
| 735 MULFORD & BIDDLE UPRR cobalt bs chips | G |
| 740 no name dark greed (black) | CB |
| 1001 CUTTER APR. 20 1904 | NM |
| 742 unemb. M. T. C. millions of bubbles make this light blue | G |

REWARD \$500.00

For information leading to the return of the above insulators: Mr. and Mrs. J. Paul Kelly, 401 National Bank Bldg. South Bend, Ind. 46601

TELEGRAPH BOOK

History, Theory and Practice of the Electric Telegraph". The original copy of this book was first printed in 1860 by George Prescott, Superintendent of Electric Telegraph lines. Over 500 pages of information on the telegraph and many illustrations of early telegraph equipment. This book also contains two sections with information and illustrations of early telegraph insulators. Reprints of this book \$7.50 each. P. P. Frank Jones A10, Box 73, Highway 25, Cottontown, Tenn. 37048.

TRADE- Have light purple CD 112 #11 OVG CO. VNM to trade for amber CD 412 Hemingray 8 in same condition. Roy Galloway, 105 Harkins Drive, Winchester, Kentucky 40391.

CHICAGO DIAMONDS \$40 mint, Consider trades on better glass. Jim Sanders, 601 Shady Ln. Ojai, Calif. 93023. (805) 646-4573.

MOST ABOUT GLASS INSULATORS—REVISED

By Milholland

2000 Glass Insulators described in complete detail. Hundreds of full size photos and machine drawings listed with Consolidated Design numbers for pin type and threadless insulators. Historical information of real interest. Complete production record of many insulators. Stories by the top authorities in the Telephone and insulator world. This 264-page hard cover book together with the 1973 suggested price list \$10.00 Post Paid.

ALSO

THE FAVORITE MILHOLLANDS No. 2 BOOK

Milhollands Glass Insulator Reference Book No. 2— Nearly 700 insulators described. Full size photos and machine drawings. Paper back book. Complete with 1973 Suggested Price List. For the beginner a must. \$4.50 post paid.

1973 Suggested Price List, separate, \$1.50 post paid.

These books from your dealer or order direct.

Marion Milholland, Rt. 2, Box 368
Sequim, Wash. 98382

FOR SALE: CD 190/191 B, aqua--\$10; CD 145 H. G. CO., jade milk--\$6; CD 108 W. T. #9 SCA--\$15; CD 102 Hawley, aqua--\$7; CD 259 Cable helmet, aqua--\$10; CD 261 Cable, aqua--\$20; CD 102 WM. Brookfield, green & aqua--\$25; CD 106 Duquesne (peak top) sky blue--\$30; PRR porcelain dome embossed PRR, brown--\$17.50. mint or vnm. Postage and insurance extra. Ed & Jeannie Szymala, 217 Spruce St., Cresson, PA 16620.

ESTA BROWN has the following for sale:

RARE HEMINGGRAYS

| | | |
|--------|--|---------|
| CD 248 | Hemingray 88 (displays good) very rare. | \$88.00 |
| CD 242 | Hemingray 66 (v. n. m.) rare. | 80.00 |
| CD 241 | Hemingray 24 (mint) aqua. | 30.00 |
| CD 303 | Hemingray 2 pc. No. 76 (mint). | 100.00 |
| CD 310 | | |
| CD | Hemingray T. S. 3 (mint) carnival. (has glass insert) | 275.00 |
| CD 307 | Hemingray High Potential (D. Good). | 75.00 |
| CD 263 | Hemingray COLUMBIA (v. n. m.) | 140.00 |
| CD 254 | Hemingray No. 3 Cable w. d. p. | 55.00 |
| CD 162 | Hemingray ambers-various shades- lovely unusual | 30.00 |
| CD 248 | Hemingray 79 aqua top + 1 skirt-- | 150.00 |
| CD 311 | 1 amber skirt | |
| CD 125 | Hemingray W. U. No. 5 (v. n. m.) medium S. C. A. | 100.00 |

TERMS MAY BE ARRANGED.

ESTA BROWN, TWO BUTTES, COLORADO 81084.

POSTPAID. VNM TO MINT. CD 214 Hemingray 43
aqua-\$3.00; CD 213 Hemingray 43, aqua-\$3.00; CD 133
Hemingray 20, aqua-\$4.00; CD 160 Hemingray 14,
aqua-\$3.00; CD 205 Hemingray 55, aqua-\$4.00-same
only blue-\$5.00; CD 157 Hemingray 38-\$9.00; CD 114
Hemingray 11, aqua-\$6.00; CD 175 Hemingray 25,
clear-\$9.00-aqua \$11.00; CD 133 1871, aqua-\$13.00
CD 190/191 B, dark aqua-\$10.00; CD 136 B&O Brook-
field dome, aqua-\$11.00; CD 145 OVG, aqua-\$5.00;
CD 134 Good, aqua-\$8.00; CD 145 NEGM, aqua-
\$4.00; CD 112 California, smoke-\$14.00; CD 145 WGM
dark sca-\$14.00; CD 160 California, smoke-\$8.00;
CD 152 California, sage-\$4.00-smoke-\$4.00-
sca-\$6.00; CD 166 California, sage-\$5.00; CD 161
California, sage-\$4.00; CD 164 Whittall-tatum 5, clear-
\$3.00; CD 165 Whittall-tatum 5, aqua-\$5.00; CD 113
star, olive green-\$7.00; CD 125 WU5A, aqua-\$4.00.
Rays Rock Shop, Box 355, Drummond, MT 59832.

Christmas is just around the corner. Time to think of giving a year's subscription of CROSS ARMS to a collector friend. Just send us \$5.00 and their name and address, we'll see that they receive a gift certificate with your name on it and come December they will start receiving CROSS ARMS.

KNOW WHAT YOU HAVE. ALL DETAILS YOU NEED on 3" X 5" index cards. 50 cards for 75¢ plus postage. Eastern Insulator Club membership plaques on wood grain plastic 2" X 8" for \$2.50 plus postage. Gene Bond, 15 East Camden Ave., Morrestown, NJ 08057.

6. In order to keep CROSS ARMS up to date we would like all reports on shows and swaps sent in no later than 45 days after the show has taken place.

ADVERTISING RATES:

DISPLAY ADS:

1/4 page - \$5.00 per issue
* \$12.00 per three issues

1/2 page - \$10.00 per issue
* \$25.00 per three issues

Full page - \$18.00 per issue
* \$45.00 per three issues

\$.05 per word (minimum \$1.00). The closing date for material will be the 15th of the month preceding the month of the issue.

Ads received too late for the deadline will be run in the next issue.

CROSS ARMS encourages want ads that list the value of the insulators advertized so any ad listing 10 or more insulators with prices will receive an additional one month's free exposure.

**CROSS
ARMS**

367 Signal Hill Road
King of Prussia, Pa.
19406

RETURN POSTAGE GUARANTEED

John R. Snyder
244 Waggoder Blvd.
Toledo, OH 43612

FIRST CLASS MAIL

