

CROSS ARMS

*an eastern
insulator collectors'
magazine*

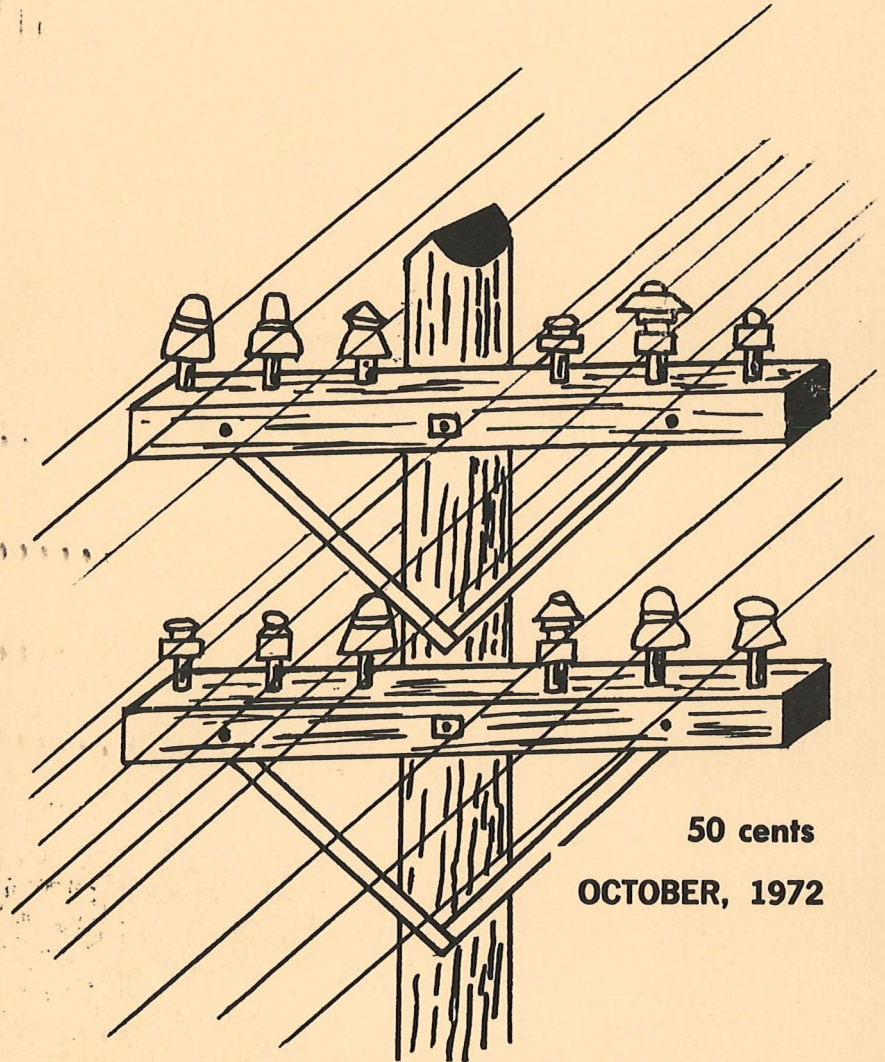

50 cents

OCTOBER, 1972

367 Signal Hill Road
King of Prussia, Pa. 19406

CROSS ARMS

An Eastern Insulator
Collector's Magazine

Vol. 1, No. 9

October, 1972

Editor James Garrity
Production Catherine, Mary Alice Garrity, Edward Szymala

Single copy 50 cents. Subscription price \$5.00 (12 issues)
Back issues available at \$.50 each.

Copyright © 1972 by CROSS ARMS

This journal is protected by copyright and no part of it may be reproduced in any manner without written permission from the publisher.

TABLE OF CONTENTS

	Page
CD of the Month (256)	17
Classified Ads	30
Eastern Insulator Club	8
Greeley Insulator	6
Know Your Collector	9
Letters to the Editor	13
Market News	29
Milhollands Play Trip	16
New Holland Bottle Show	12
Patent Information	21
Shows and Swaps	2
Title Page	1

CD of the month for November is 203.

Any information on our CD would be appreciated.

SHOWS AND SWAPS

This section is free of charge to anyone interested in having an announcement of their coming show published. We will be glad to print any information you would like to send to us. CROSS ARMS will furnish award ribbons to any show or swap meet that requests them. Any club or show host interested in awarding CROSS ARMS ribbons please contact us for particulars.

The guide for the calendar is as follows:

(B. S.) for bottle show.

(I. S.) for insulator show and swap.

(+) indicates more information is available on the following pages.

CALENDAR

OCTOBER

- 1 (I. S.) (+) Middletown, N. Y., B. S. Enterprises.
- 1 (B. S.) Canton, Ohio. Imperial House Motel.
- 7, 8 (B. S.) Charleston, S. C. Frances Marion Hotel.
- 7, 8 (related telephone items) Coffeyville, Kansas.
- 8 (B. S.) Bridgeport, Conn.
- 14, 15 (I. S.) (+) St. Charles, IL.
- 17 (B. S.) Willingboro, N. J. Vol. Fire Co.
- 21, 22 (B. S.) Glendale, CA. Civic Auditorium.
- 21, 22 (I. S.) El Paso, Texas. Nat'l Bank Bldg.
- 22 (S) Keene, N. H. Keene Recreation Center.
- 22 (I. S.) (+) Cromwell, Conn.
- 22 (B. S.) Columbus, Ohio. Ramada Inn.
- 22 (B. S.) Pittsburgh, PA. Sheraton Motor Inn.
- 29 (B. S.) (+) Sellersville, PA.

NOVEMBER

5 (I. S.) (+) Vienna, VA. Eastern Insulator club.

'73 CALENDAR

APRIL

14, 15 (I. S.) (+) Ithaca, N. Y. High School.

29 (I. S.) (+) Rehoveth Beach, Del.

JUNE

10 (I. S.) (+) Greater Harrisburgh Area, PA.

JULY

7, 8 (I. S.) Hutchinson, Kansas. Sports Arena. Fourth National Insulator Meet.

ADDITIONAL INFORMATION

OCTOBER 14 & 15

The site of the first Annual Chicago Mid-West National Insulator "JUMBO" show will be Kane County Fairgrounds.

There will be 200+ tables available inside large building, outside set-ups available--300+ car parking. Lightning rod balls, arrows and vanes will be a special feature at the show.

Display tables are \$10/day; booths (3 tables)-\$25/day. For reservations: (312) 766-3705 or write Dick Augustyn, 650 South Harvard Ave., Addison, IL 60101 or Larry

Veneziano, 324 Hawthorne Dr., Bensenville, IL 60106.

OCTOBER 22

YANKEE POLE CATS INSULATOR CLUB SHOW AND MEETING. Oct. 22, 10:00-5:00 at the Cromwell High School on Geer St., Cromwell, CT. Meet the Milhollands. CROSS ARMS and CROWN JEWELS ribbons to be awarded for best display. Table space \$2.00 for members, \$3.00 for non members. For table space contact: Mrs. Lawrence Wyer, 29 Franklin Rd., Cromwell, Conn. 06416. Tel.: 346-5318.

OCTOBER 29

Delaware Valley Bottle Club will hold a show and sale at the V.F.W. Forrest Lodge, Rt. 309, Sellersville, PA. from 10 a.m. to 6 p.m. Featured will be inks, fruit jars, flasks, insulators, etc. Free parking. Admission will be \$1. Meet the Milhollands in person. For information on table space write: Midge Jurin, Box 330, Rt. 152, Perkasio, PA. 18944 or call (215) 257-4185.

NOVEMBER 5

Eastern Insulator Club 1972 Fall Show and Sale. Vienna Vol. Fire Dept., 400 Center St. South, Vienna, VA. Guests of honor will be Mr. & Mrs. Marion C. Milholland. Contact: O.B. Crockett, 5710 Belfast Lane, Springfield, VA. 22150. (703) 451-7555 or Jim Barron, 6815 Darby Lane, Springfield, VA 22150 (703) 971-1647.

WE ARE LISTING THE '73 SHOWS SO THAT ANYONE WISHING TO PLAN A MEET OF THEIR OWN WILL NOT CONFLICT WITH ANOTHER PLANNED SHOW.

'73

APRIL 14 & 15

Brad & Nancy Cook of Ludlowville, N. Y. will hold their meet at the High School, Ithaca N. Y. More information to follow later.

APRIL 29

First State Insulator Swap Show and Sale at Rehoveth Beach Convention Hall. 100 tables available. Opens at 6 a. m. for dealers and 9 a. m. to 5 p. m. for public. Admission will be free. Tables are \$7 and \$5 for 1/2 table. There will be door prizes and ribbons. Please have reservations in by April 15 to Charles Irons, Jr. No. 3 Elizabeth St., Milford, DE 19963.

JUNE 10

First Pennsylvania Insulatc. Show June 10, 1973. Greater Harrisburg, Pa Area. More information in later issues. Ed & Jeannie Szymala, 217 Spruce St., Cresson, PA, 16630

FEBRUARY 4

A show and swap will be held at Bergenfield, N. J. Ribbons will be awarded. Tables will be \$5 per table, \$3 for half table. Tables will be 8 foot. Contact: Jerry Wagner, 15 N. Demarest Ave., Bergenfield, N. J. 07621.

G R E E L E Y by Penni Branham

I noticed in your August issue of CROSS ARMS a picture of a CD 188, embossed Greely, N. Y. I don't know if this was a printing error or a mistake on the actual insulator, but this little gem is supposed to say Greeley. Thinking you might be interested in a little follow-up information, I enclose a short biography.

Edwin S. Greeley was a banker and businessman who lived most of his life in New Haven, Conn. He entered the Civil War as a First Lieutenant in the 10th Connecticut Infantry and rose to be its colonel, later being brevetted Brigadier General for gallant services. (Brevetted means being promoted to higher rank without higher pay.) On November 1, 1865, General Greeley, along with a Mr. W. H. Holt, and Luther G. Tillotson, founded the house of L. G. Tillotson & Co. at 26 Dey Street in New York City. (You will remember that Tillotson had founded his business several years before this, but apparently he was able to expand greatly with the additional capital of two partners. Shortly afterwards, he resigned his superintendency with the Erie RR Telegraph to devote full time to his business.)

Mr. Tillotson died in 1885, and 1886 the name of the firm was changed to E. S. Greeley & Co. A late 1880's ad read:

E. S. Greeley & Co.
Successors to L. G. Tillotson & Co.
Manufacturers, Importers and Dealers in
Railway and Telegraph Supplies
Nos. 5 and 7 Dey St.

The firm offered the same goods and services as it did when under Tillotson's command, emphasizing electrical

supplies in later years.

The "Brown's Pony" style insulator was patented by Robert G. Brown (assigned to E. S. Greeley & Co.) on Nov. 23, 1886. Since Greeley was involved in the patenting of the insulator, the embossed Greeley just might be one of the original "Brown's Ponies."

Wish I could say who made the Greeley insulators. Since Brookfield was so successful during this period, I thought first of him. He was still at 45 Cliff St. in 1886, and it is very possible that Greeley contacted him to make his insulators. From 1890-1894, however, Brookfield and Greeley were neighbors, Brookfield being at 81 and 83 Fulton Street, and Greeley being at 82 and 84 Fulton Street. What a co-incidence--makes you think that Mr. Greeley ran right across the street to Friend Brookfield to place his order for insulators--and all this is pure speculation!

Well, Mr. Greeley remained with the business until 1905. He was getting on in years then, and retired, probably with a bundle. He died in January of 1920, in his eighty-seventh year.

A 1900 Locke Victor catalog illustrates the Locke line of glass insulators available for purchase. Most of the insulator shapes have already been located by collectors and identified by their embossings. Here are four that to my knowledge have not been found.

Locke #48-CD 259

Locke #51-CD 254

Locke #50-CD 252

Locke #52-CD 267

Another interesting note: CABLE is the most common found embossings on these CD's. The only loose end left is CD 261 which is also embossed CABLE. Editor.

EASTERN INSULATOR CLUB
by Bill Spell, Club Secretary

FALL SHOW TO BE SELLOUT

Half the tables for the Eastern Insulator Club's Fall Show and Sale are already reserved. To date reservations have been received for the November 5th Vienna, Va., Show from collectors in Pennsylvania, New Hersey, Virginia, Delaware, Maryland, Kentucky and New York, with more states expected to be represented once all reservations are in. Mr. and Mrs. Marion Milholland will be on hand to meet collectors and autograph books, and door prize drawings are planned for throughout the day. Jim Garrity, CROSS ARMS Editor, will be there too, to present his magazine-sponsored awards to outstanding displays. By all means, get your reservation in early. Space is limited!

NEW CLUB MEMBERS WELCOMED

The Eastern Insulator Club grew to a membership of 101 members in 16 states plus the District of Columbia this past month. Welcomed to membership were Jay Barley of Chester Springs, PA.; Thomas A. Jones of Sandston, VA.; E. M. Lent Jr. of Richmond, VA.; Roy Galloway of Winchester, KY.; Richard Von Lusch of Stevensville, MD.; Norman Beauregard of Absecon, NJ; T. B. Hood of Midlothiam, VA; and John H. Knowles of Chevy Chase, MD.

MEMBERS COVER SHOWS

Members of the Club visit shows all over the country and are asked to report to the Club Secretary on their travels.

KNOW YOUR COLLECTOR

Collectors of the month are Dolph and Lucille Barlow of Buckingham, PA. Dolph and Lucille have been collecting about 3 years. They are very enthusiastic collectors, attending every show and swap meet possible. Their constant search for new insulators has brought their name before most insulator collectors in the country. Marion Milholland visits with the Barlows every year during his research trip. Their door is never closed to collectors.

Lucille also takes an active part in a local bottle club and is a devoted "digger."

Dolph and Lucille are pictured below with some of their best pieces which are displayed in an old mail post office cabinet which they have restored.



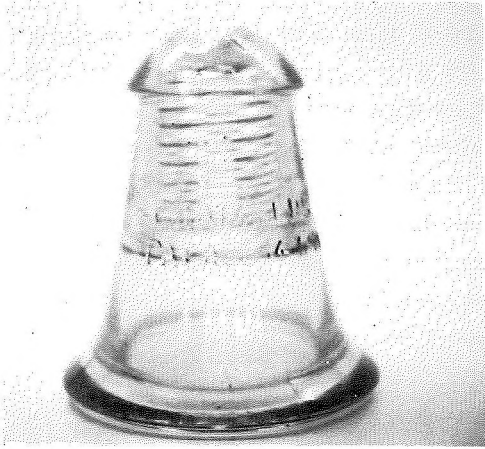

l to r: Chambers CD 617 embossed (F): CHAMBERS PAT AUGUST 14, 1877 (B) PATENT DEC 19, 1871; CD 739, unembossed threadless.

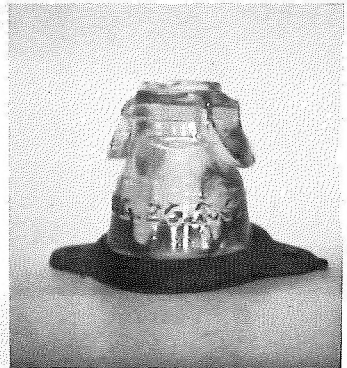
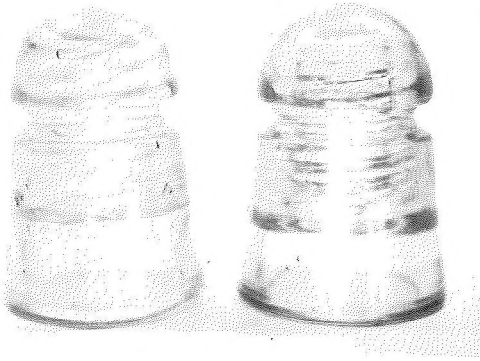

l to r: arc embossed W. BROOKFIELD NEW YORK-base embossed NATIONAL INSULATOR CO PAT JAN 1 & OCT 7, 1884; at first glance this lightning rod insulator looks like a Fisher, but it is embossed: PATENTED AUG 26, 1851.

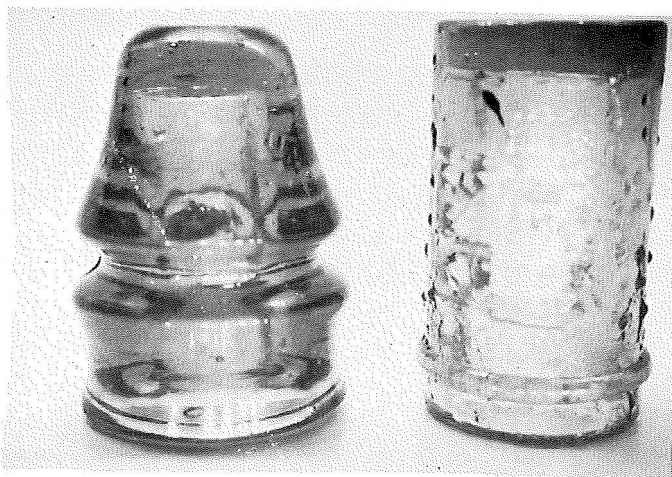

l to r: CD 731 dome embossed Tillotson (blue);
Wade CD 723 Dots and Dashes (apple green).

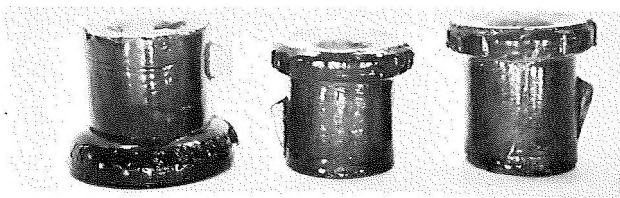
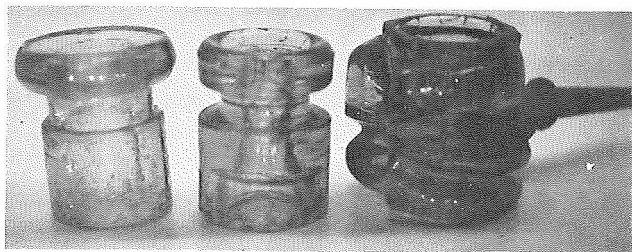

These six lightning "thru holes" are a small sampling
of Dolph and Lucille's lightning collection (colors
range from aqua, sca, & emerald green).

NEW HOLLAND BOTTLE SHOW & SALE

On Sept. 3, the New Holland Bottle Club held a show and sale at the Liberty Fire Hall in New Holland. The show was attended by over 600 bottle and insulator collectors. 40 dealers displayed their wares and among them were 7 insulator collectors and about 15 tables which featured both insulators and bottles.

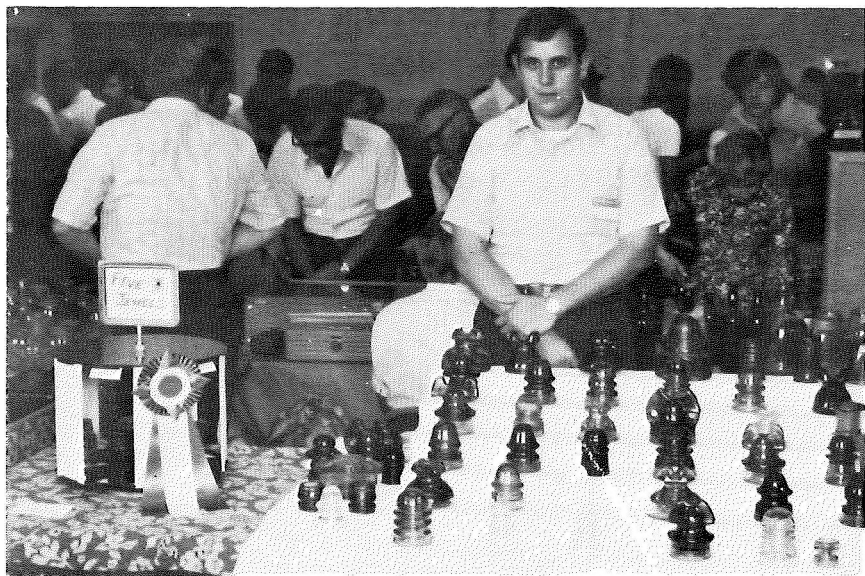

First place (Best in Show for insulators) went to Fred Garner of Pottstown, PA. The Five Jewels he displayed were : Cal. Elec. Works--E.C. &M. (cobalt)--Harloe (claw)--Corkscrew (segmented threads)--and the Castle.

(More pictures Pg. 29)

LETTERS TO THE EDITOR

Dear Jim,

The letter in your Sept. issue from Mr. J. L. Mingle Sup't telegraph L. & S. R. R. adding testimony to the value of the Brook's Paraffin Insulator comes from the Lehigh & Susquehanna Railroad.

According to the June 1868 Official Railway Guide this railway extended from Scranton, Pa. to Easton, Pa. a distance of 121 miles where it connected with the Central RR of NJ for New York City.

The L. & S. R. R. was operated by the Lehigh Coal and Navigation Co. The railroad was later acquired by the Jersey Central.

Nice meeting you at the Bergenfield Meet which we all enjoyed.

Sincerely, Don Wentzel

* * * * *

Dear Editor,

I read with interest your article on the Brook's Paraffin Insulator in the Sept. issue of your magazine.

In reference to your question on the L. & S. R. R. , I believe it stands for the Lehigh and Susquehanna Railroad which was part of the Jersey Central system.

In recent months I have done much research into the meaning of the P. L. W. as it appears on the CD 462. I have heard ventured many possibilities, two very amusing definitions are the Pennsylvania, Lackawanna and Western (a non existent line which seems to have borrowed its name from the old Delaware, Lackawanna

and Western) and the Pittsburgh Light and Water Company.

From the outset I have thought that the P. L. W. must be related to the P. R. R. because of the similarity of their insulators, and I have guided my research in this direction. To date I have come up with the following: On April 7, 1870 the Pennsylvania Railroad Company formed the Pennsylvania Company whose purpose was to hold and manage all P. R. R. lines west of Pittsburgh and Erie, Pa. In the literature I have researched the Pennsylvania Company is referred to as the Pennsylvania's "Lines West" system. This leads me to speculate that the P. L. W. embossed some CD 462's stands for Pennsylvania's "Lines West." It would be interesting to know where P. L. W. insulators are found. I'll bet that the majority are found west of Pittsburgh and Erie, Pa.

Enclosed please find a copy of a story concerning the P. R. R., Western Union Telegraph Co. and Postal Telegraph Co. which may prove of interest.

Very truly yours, Dan Rider
Buffalo, NY

* * * * *

Reprint from Burgess, G. H. and M. C. Kennedy (1949). "Centennial History of the Pennsylvania Railroad Company page 515, 516:

One of the interesting episodes in the Gould-Pennsylvania struggle had to do with the Western Union Telegraph Company, which was controlled by the Gould estate. This company had a 20 year contract for the occupancy of the Pennsylvania's right of way and other facilities which expired in September 1901. Negotiation

for the renewal of the contract had been begun some-time prior to its expiration date, but the parties had been unable to agree on the terms. In due course, the Railroad Company decided to substitute the Postal Telegraph Company for the Western Union, and served formal notice on the latter company to remove its poles and wires and other property from the right of way. When no response was made to this demand, the railroad offered to buy the lines. This offer was likewise ignored and Western Union brought suit to enjoin the Pennsylvania from interfering with its property. The Federal Circuit Court for the District of New Jersey issued the injunction prayed for, but on appeal it was reversed by the Circuit Court of Appeals and the rights of the Railroad Company thus fully established.

This decision was handed down on May 19, 1903, and President Cassatt decided there was nothing more to wait for. On the night of May 21, the section gangs, extra gangs, and work trains were called out all over the railroad, and by the following morning, the poles of the Western Union Company had been torn down from one end of the railroad to the other, and the right of way was lined with a tangled mass of wire and timber. This was probably as drastic an act of eviction as has ever occurred in railroad history.

Courtesy of Dan Rider of Buffalo, NY.

NOTICE: On Oct. 25, 10:00 a.m. at N. A. S. Quonset Point RI. Sale #16-3031 of the DSSO agency, Federal Government will take place. One of the items will be lot #70 insulator standoff P.P.I. approximately 6000 pieces.

MILHOLLANDS PLAN TRIP

The Milhollands will be starting their '72-'73 research trip, Oct. 1, 1972, continuing 'til March '73. They will start from Sequim, Washington, and work their way east. Then as the snow starts to fly, they will start toward the south.

Marion and Evelyn try to stop along the way and meet with individuals as well as groups, so they can add to their insulator knowledge. The Milhollands always have their mail forwarded so that if anyone wishes them to stop by just drop them a line--of course, the earlier the better. The mailing address is: Mr. & Mrs. Marion Milholland, Rt. 2, Box 368, Sequim, WA 98382.

At this printing we know of 4 places Marion & Evelyn will be stopping. They are:

- Oct. 1 & 15-The First Jumbo Show in Chicago, IL.
- Oct. 22-The Yankee Polecat Meet, Cromwell, CT.
- Oct. 29-The Del-Val Bottle Show, Sellersville, PA.
- Nov. 5-The Vienna Show of the Eastern Insulator Club.

Marion is collecting information about all the new finds that have come up since his last research trip. Anyone having a new find either embossing or shape, Marion will be most anxious to see. Plan to attend any of the above meets and pass to Marion any new information you have come across. He will then make sure the collecting public becomes versed on your new find.

The above pictures show the three known variations of CD 256. Pictures courtesy of Hank Hallam of Drexel Hill, PA.

"A" is the standard Manhattan (as pictured in Milholland's book).

"B" is the "squat" or "baby" Manhattan (wide groove).

"C" is the "squat" or "baby" Manhattan with a standard groove.

Note: Manhattans were made to receive a #3 cable in their wire groove.

LIST OF EMBOSSINGS:

Front: MANHATTAN

Front: MANHATTAN

Back: PATENTED JUNE 17, 1890

This page is easily removed and placed in a three ring notebook for your convenience.

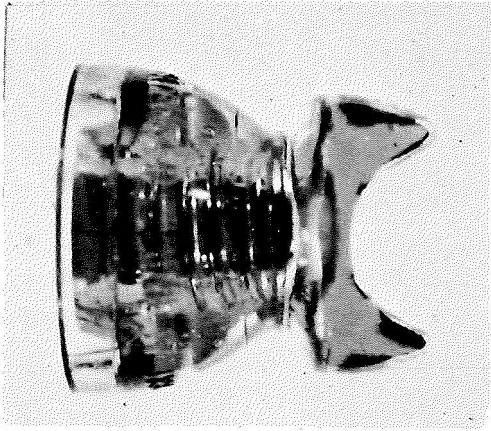

A

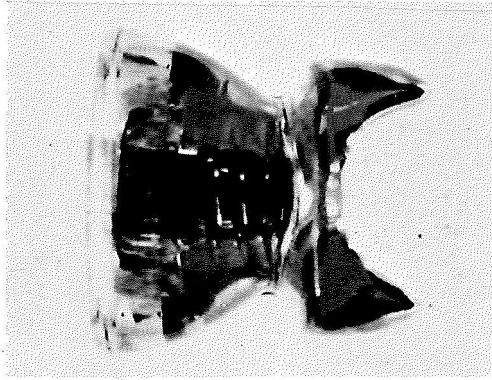

B

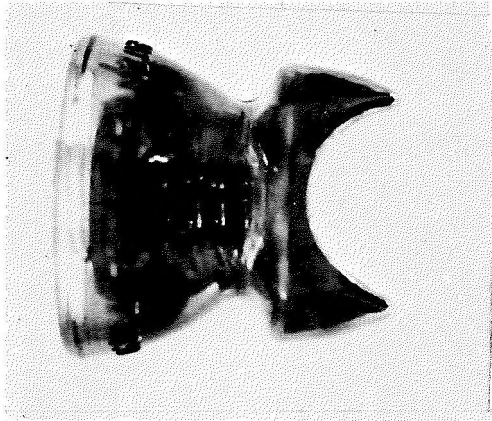

C



PATENT INFORMATION

Thomas F. Gaynor, Louisville, KY., assignor to the Gaynor Electric Company. 437,685.

Be it known that I, Thomas F. Gaynor residing at Louisville, Kentucky, have invented a useful Improvement. in Insulators.

My invention relates to improvements in insulators for electric wires, its object is to provide an insulator which shall indicate the nature or kind of wire it is designed to support.

"A" represents the insulator, which is of the ordinary glass form, having the internal thread "B", cylindrical cavities "C" and "D", and external groove "G", like all others of its class. Upon its surface, however, a coating "E" of light-reflecting material, is glazed or otherwise united thereto, by which the light from the sun or sky is reflected, thereby giving the insulator a peculiar and attractive appearance compared with ordinary insulators. This glaze may consist of colored glass or other glazing substances adapted to glass, and may also cover a coating "F" of mercury or the like. It may also extend over the entire surface of the insulator, or it may be limited to the inner cavity. I find that a red color applied to the insulator produces a very desirable effect for this purpose, although any suitable color or combination of colors may be made, as desired.

A telegraph-line provided with insulators having this improvement can be readily identified and distinguished from others among which it may be placed.

Patented Oct. 7 1890

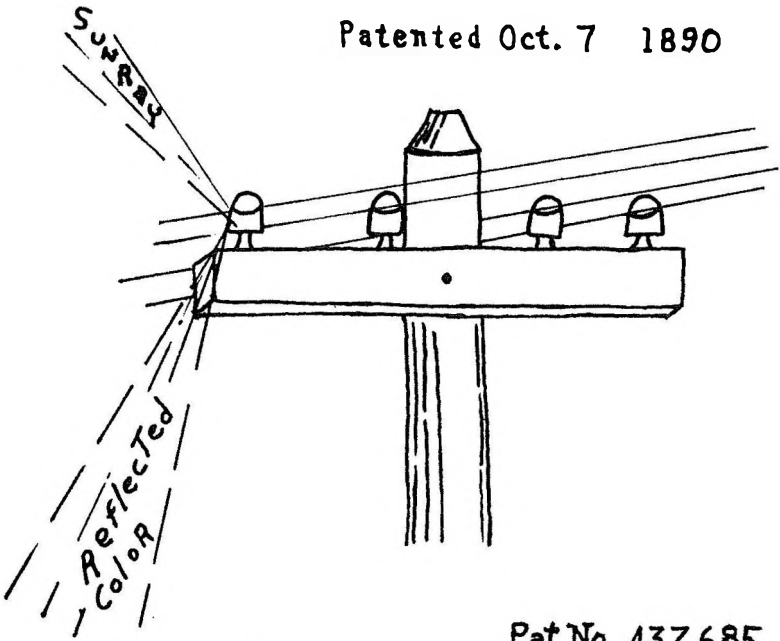

Pat. No. 437,685

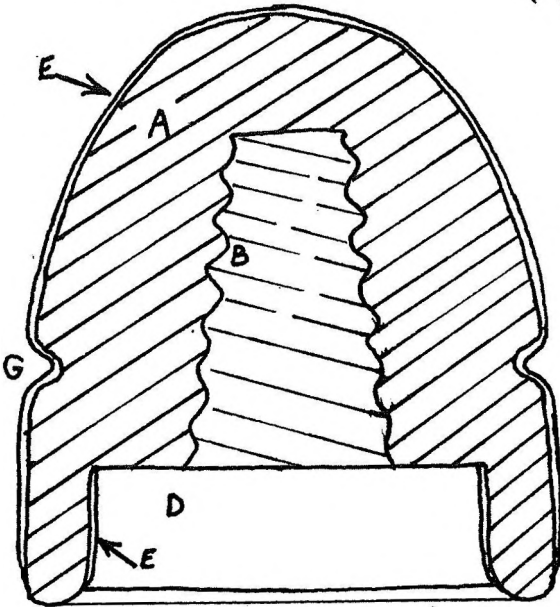

Inventor:

Thomas W. Gaynor

Patent No. 254,610, dated March 7, 1882.

Be it known that I, William H. Capewell, residing at Philadelphia in the State of Pennsylvania, have invented certain new and useful Improvements in Insulators for Telegraph-Wires.

This invention relates to insulators for holding telegraph-wires; and it consists in an improved construction of the insulator, as herein shown and described.

Fig. 3 represents a transverse central section of the insulator as constructed with my improvement.

A designates a semi-spherical block of glass or other material that is a non-conductor of electricity, said block resting in a socket in the supporting piece or holder "B". Across the rounding surface of the block "A", and following the line of the surface, is made a groove, "a", to receive the telegraph-wire "b", which passes through the groove, as shown.

"C" indicates a block of glass the exact counterpart of "A", and as both are cast or formed in the same mold they may be transposed in position, the concavity of one fitting the convexity of the other, and vice versa. The wire, being placed in the groove, is bent and clamped between the two blocks.

The parts "B" and "D" forming the casing are usually hinged together at one end.

I claim--in an insulator, one or more blocks "A", having a rounding surface and a concave surface, "c" and provided with groove "a", substantially as and for the purposes described.

W. H. CAPEWELL.

No. 254,610.

Patented Mar. 7, 1882.
Fig. 1.

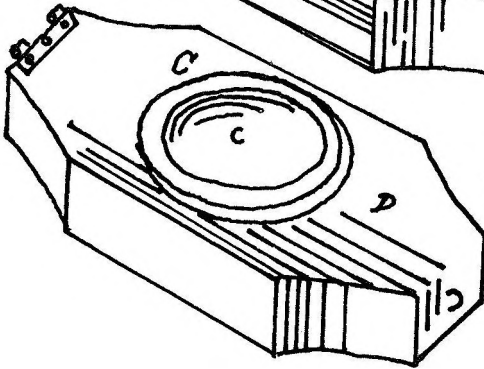
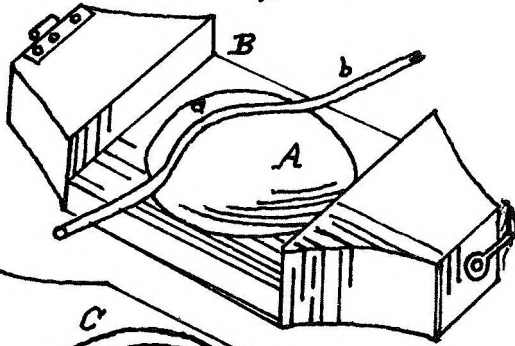
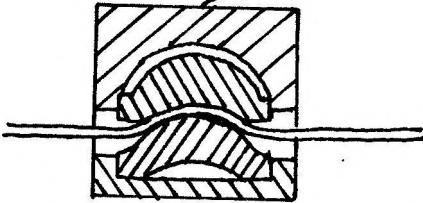
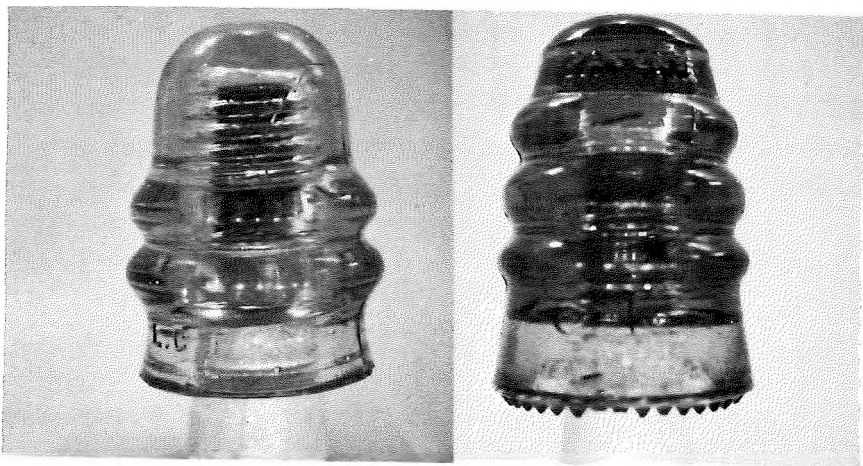

Fig. 2.

Fig. 3.



Inventor :
William H. Capewell



left: From Jerry Wagner of NJ, L. G. T. & CO
 PAT. JAN 25, 1870 FEB 22, 1870; right: from
 Howard Makela of NY CD 116 (dome) DEC 19, 1871
 (skirt) (front) PATENT MAY 2, 1893 (back) July 1
 1892 PAT APPLIED FOR.

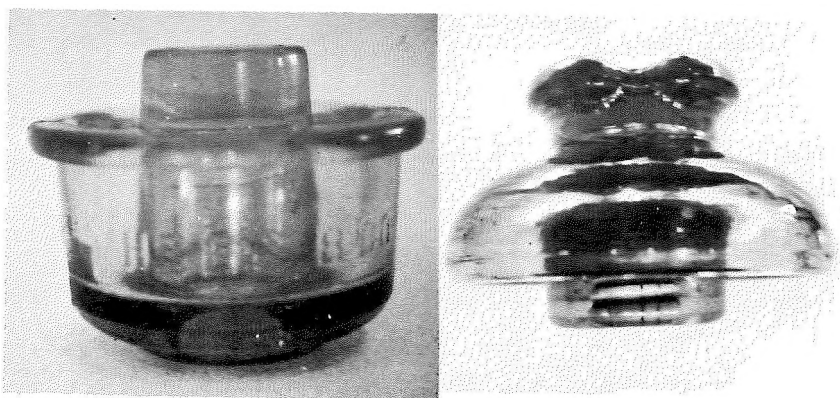

left: CD 532 embossed HEMINGRAY MADE IN
 USA (honey amber) from Bob Wilson of Phila. PA.
 right: (bird feeder) embossed E. S. B. CO. from
 Ev and Dick Bowman of Webster, NY.

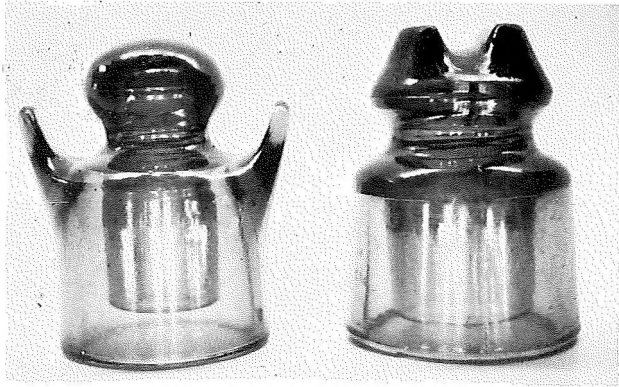

left to right: CD 781 and CD 822, both are French-
from Peg Hotton of Bethesda, Maryland.



left: no name, top is clear, bottom is a vasoline car-
nival color from Jim Boyd of Springfield, VA; right:
LYNCHBURG 181-CD 306 From Charles Irons of Dela-
ware.

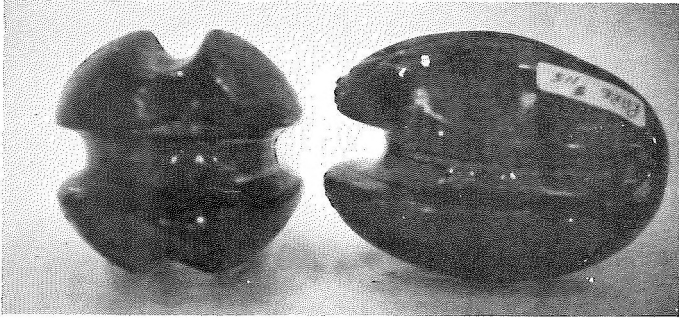

Two views of the California Egg--Guy strain insulator embossed CALIFORNIA no CD no. From Ray Richter of Mt. Shasta, California.

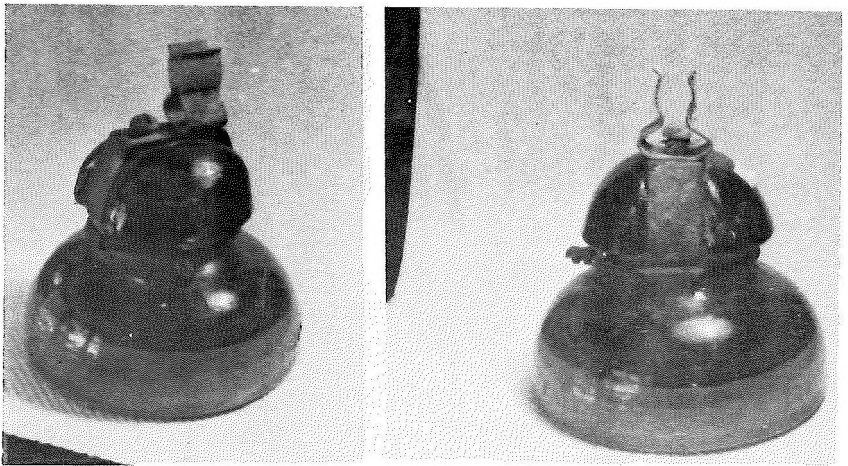

Fuse clips mounted on a CD 292. Ray Richter found this in an antique shop in Ohio.

New Holland Show.



Second Place: Walter Hasiak of New Hope, PA



Third Place went to Bob and Carol Meszaros of Titusville, NJ.

MARKET NEWS

Published under "new developments" in the August issue of CROSS ARMS (pg. 19), was a short item about Fred Hildebrand and his study concerning the deposited coating on glass insulators. Fred has sent me a copy of his report. The report is extremely exact and very detailed. I had planned to publish this report, but after reading it, I feel it will probably not be of interest to most readers. If anyone wants to read it I will be glad to send them a photostat copy of the original report. Just drop me a line and I'll send it out to you.

TOD'S NEW BOOK OUT

We received Jack Tod's 1972 Supplement to his book PORCELAIN INSULATORS GUIDE BOOK FOR COLLECTORS. We find this supplement to be of the same quality as his book and its thoroughness compliments its author. If you have already received Tod's book and like it, you will certainly want to get his supplement.

Going Priced of Insulators

New Holland Show

Manufacturer	CD	Condition	Color	Prices
McKee	431	mint	aqua	\$225
No name	728	mint	aqua	100
Hemingray	428	mint	clear	24
Lynchburg	306	v. n. m.	aqua	200
Hemi. #23	241	mint	amber	23
Hemi. 54 A&B	190/91	mint	purple	45

CLASSIFIED ADS

Huge list of insulators and lightning rod balls for sale.
SASE Paul McManis Route 1, Box 116 Excelsior, MINN
55331.

ATTENTION: TRADERS, COLLECTORS! Let's exchange lists. I have many rare, beautiful, colored insulators. Like to trade for those I do not have in collection common or rare. Northern Ohio Insulator King. William Sapara, 7609 Grand Division, Garfield Heights, Ohio 44125.

INTERESTED IN JOINING A CLUB FOR INSULATOR COLLECTORS? CONTACT: JIM BARRON, TREASURER, EASTERN INSULATOR CLUB, 6815 DARBY LANE, SPRINGFIELD, VA 22150.

NEW INTEREST - - Buying lightning rod balls and go withs (no plain milk glass or rounds unembossed) also all types arrows and weather vanes (animal); Still paying top cash prices for rare insulators need glass harloe, threadless, etc. Please send description and price first letter. L. Veneziano, 8310 Center, Rivergrove, IL 60171.

TELEPHONE PIONEERS PILGRIM HAT COMMEMOR-atives - \$15.00 each, \$100.00 set of eight. Limited quantities; list 2nd choice on single color order. Colors: cobalt blue, green, white milk, amber, azalea, orange, carnival, blue carnival and blue haze. Will consider trades - make offer. "Davy" Crockett, 5710 Belfast Lane, Springfield, VA 22150. Tel. (703) 451-7555.

I specialize in threadless insulators and will buy, sell, or trade. Send SASE for current list of threadless types for sale, including several nice Wades priced reasonable. Dennis Rogers, 1406 N. Amador, Ontario, CA 91764.

INSULATORS FOR SALE. Send SASE for wants to Ferd Huber, 385 Allendale Rd. King of Prussia, 19406. tel. (215) 265-6432.

MOST ABOUT GLASS INSULATORS—REVISED

By Milholland

2000 Glass Insulators described in complete detail. Hundreds of full size photos and machine drawings listed with Consolidated Design numbers for pin type and threadless insulators. Historical information of real interest. Complete production record of many insulators. Stories by the top authorities in the Telephone and insulator world. This 264-page hard cover book together with the 1973 suggested price list \$10.00 Post Paid.

ALSO

THE FAVORITE MILHOLLANDS No. 2 BOOK

Milhollands Glass Insulator Reference Book No. 2— Nearly 700 insulators described. Full size photos and machine drawings. Paper back book. Complete with 1973 Suggested Price List. For the beginner a must. \$4.50 post paid.

1973 Suggested Price List, separate, \$1.50 post paid.

These books from your dealer or order direct.

Marion Milholland, Rt. 2, Box 368
Sequim, Wash. 98382

INSULATORS ONLY: Interested in trading. Have common and rare canadian. Will exchange lists. Ivan LeBlanc, 401 Whittier Ave. East, Winnipeg, Canada R2C OM6.

SALE or TRADE: Oakman & Hemi Col., L. G. T., Corkscrew, #4 Cable, Cal. Elec., H. Brooks, Amer. pony, & many more. Large SASE. Jerry Wagner, 15 N. Demarest Ave., Bergenfield, N.J. 07621.

INSULATORS FOR SALE: CD 162--H. G. Co.--Hemin-gray--Cobalts V. N. M. \$20.00; Ambers \$6.00 to \$12.00-- Also CD 160 California--McLaughlin--Lynchburg-- Postage \$1.00 for first Insulator and \$.50 cents for each additional. R. Green, 1703 NE 72 Terr., Gladstone, MO 64118.

Trade or Sell: CD 187 Greeley, NY, CD 102-133-134-162; BGM's (SCA); CD 252 McLaughlin emerald green; CD 133? Star SDP. Prefer Calif-Stars-H. G. Co. Gary Hill, 1949 Marlow, Toledo, Ohio 43613.

GLASS INSULATORS FOR SALE
Private Issue No. 2 / Columbia / LSV
threadless (NOT a Repro) Private
Issue. Limited Amount - Lime Green
and/or lighter (7-up) green @\$20.00
each Mint. VERY Near Mints @\$15.00
Near Mints @ \$10.00 each Plus post.

Veneziano
324 Hawthorne Drive
Bensenville, Ill. 60106

THE



**SWAP
&
SELL**

DISPLAY

PRESENTS IT'S 1972 FALL SHOW

SUNDAY - NOVEMBER 5TH - VIENNA, VA.

Vienna Volunteer Fire Department
400 Center Street South
Vienna, Virginia

10 a.m. till 7 p.m.
Public Admission - 75¢

Meet the MILHOLLANDS in person

Authors of Most About Glass Insulators and Most About Glass Insulators - Revised

FREE ADMISSION to members of THE EASTERN INSULATOR CLUB not selling or displaying

Awards-Door prizes

Food-Refreshments

Cost per table	1/2 table
Non member - \$5	\$3
Member - \$3	\$2

Display tables are free, but number of tables is limited and reservations should be sent in early.

JIM GARRITY Editor of CROSS ARMS Magazine will attend the show and present CROSS ARMS awards for the best displays.

For reservations or further information, call, or mail the form below to:

O. B. Crockett, President, Eastern Insulator Club
5710 Bellfast Lane Springfield, Va. 22150

703-451-7555

WANTED: Pyrex 701 and threadless. Send SASE for new glass-porcelain list. Maury Tasem, 519 Verdin St., El Cajon, CA 92021.

PORCELAIN INSULATORS GUIDE BOOK FOR COLLECTORS, a comprehensive original research book and complete collector's reference for unipart pin type porcelains. Universal Style Chart with scale drawings of every unipart pin type shape, manufacturer's markings, pricing guide, company histories, etc. The standard for collectors and mail traders. Hardbound, 206 pages, \$10 postpaid. Also 1972 Supplement, \$1.95 postpaid. Jack H. Rod, 3427 N. 47th Place, Phoenix, Arizona 85018.

WANTED: "kegs" & "Baby Signals"- CD 112, 113, 114, 115, 116, 117, 412, 413, 416 & CD 160. Will buy or trade. Send list of what you have, condition & price. "Davy" Crockett, 5710 Belfast Lane, Springfield, VA. 22150 Tel. (703) 451-7555.

Insulators, Sale, E. C. & M., California, Western Glass. Variety from \$1.00 up. Send SASE for list. S.H. Bayes, P.O. Box 357, Baker, Calif. 92309.

FOR SALE: mint Hemingray #50's CD 190-191 clear-\$3.50 each. Postage & Insurance extra. Robert Costello, Box 85, Southfields, NY 10975.

CD 135 Chicago diamond groove for sale--\$40.00 dome embossed n.m.; base embossed n.m. \$45.00. Postage and insurance paid. J.E. Durham, 14110 S.E. 172nd Ave., Clackmas, OR 97015.

"Latest insulator list just out." Lowest prices anywhere. 200 different to chose from. Let us put you on our mailing list if you buy! Send large S. A. S. E. to Brad & Nancy Cook, 507 Ridge Rd., Ludlowville, N. Y. 14862.

FOR SALE: D-512 carnival (real good color) \$20.00; Manhattan, blue-\$30.00; Hemingray 25 aqua-\$10.00; Hemingray 55, blue-\$5.00; Colored Micky Mouse n.m. \$8.00; 7 up green No. 9's-\$6.00; 54 A/B purple-\$35.00; CD 205 Brookfields (inner skirt chip) \$6.00; Columbia Hemingray-\$60.00; amber Hemingray 23-\$20.00; Fog Bowls-\$6.00. Please write wants. All above mint or v. n. m. unless stated otherwise, plus postage. L. Veneziano, 8310 Center, Rivergrove, Ill 60171.

Have a few Chicago Diamond Grooves for trade in quantity. Need cobalt California Electric Works, cobalt E. C. M. and any threadless I don't have. J. E. Durham, 14110 S. E. 172nd Ave., Clackmas, OR 97015.

TRADE: CD 426 W. E. MFG CO. (CROSS ARMS CD of the Month for Sept.), CD 126 crown embossed W. Brookfield, CD 122 McLaughlin 16 light green. Jim Henrie, 8705 James N. E., Albuquerque, New Mexico 87111.

WANTED: E. C. & M's all kinds and colors, will pay cash. For Trade Tod's U-855 glaz-weld Locke Fog Bowls \$10.00 cash, \$12,00 trade. Glass or porcelain. Jim Wright, 7800 DeBarr Rd. #371, Anchorage, Alaska, 99504.

SODAS

ye

INSULATORS

BOTTLE CLUB

Del-Val

SHOW & SALE

FIGURAL

AT THE V.E.W.

PERFUMES

FORREST LODGE

ROUTE 309.. SELLERSVILLE

OCTOBER 29th PENNA.

10A.M. TO 6 P.M.  FRUIT JARS

 \$1.00 ADMISSION BEERS

FOR INFORMATION ON TABLE SPACE

WRITE MIDGE JURIN
BOX 330 ROUTE 152

PERKASIE PA 18944

CALL 257-4185



Meet The Milhollands In Person

19

72

**CROSS
ARMS**

367 Signal Hill Road
King of Prussia, Pa.
19406

RETURN POSTAGE GUARANTEED

John R. Snyder
244 Waggoner Blvd.
Toledo, OH 43612



FIRST CLASS MAIL