

CROSS ARMS

*an eastern
insulator collectors'
magazine*

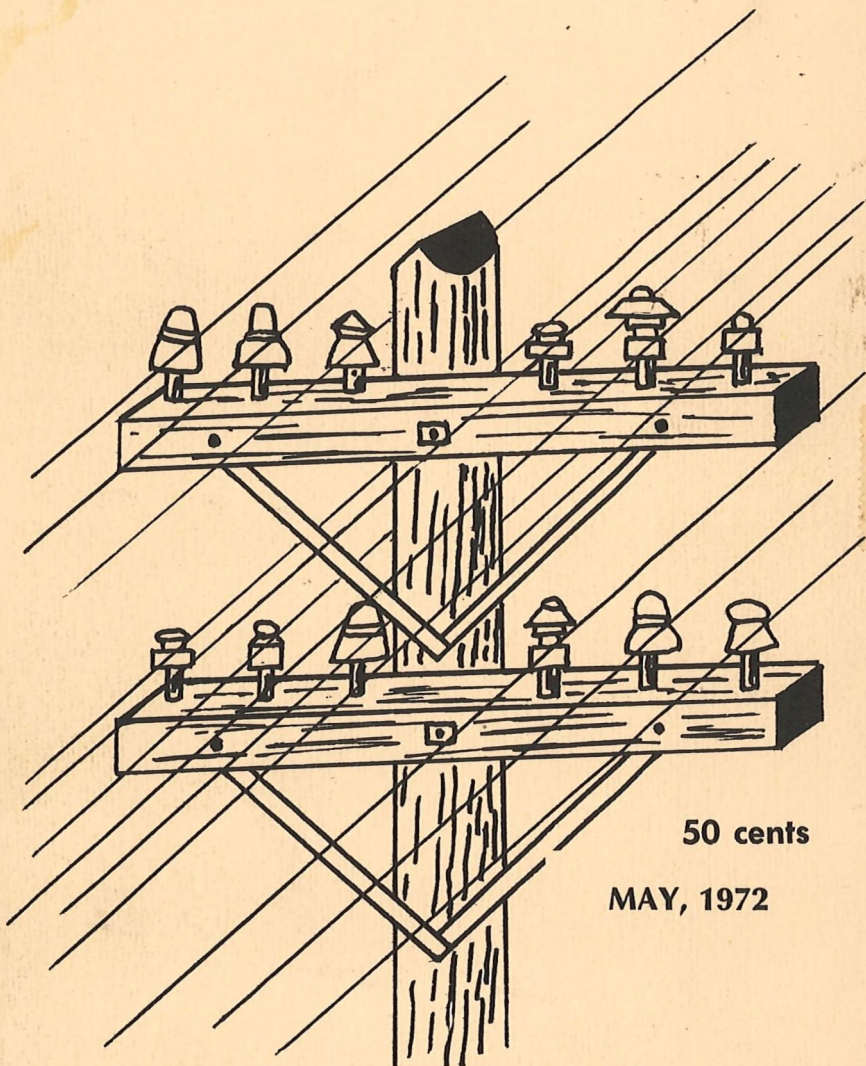

50 cents

MAY, 1972

367 Signal Hill Road
King of Prussia, Pa. 19406

CROSS ARMS

An Eastern Insulator
Collector's Magazine

Vol. 1, No. 4

May, 1972

Editor James Garrity
Production Catherine, Mary Alice Garrity, Edward Szymala

Copyright © 1972 by CROSS ARMS

This journal is protected by copyright and no part of it may be reproduced in any manner without written permission from the publisher.

TABLE OF CONTENTS

	Page
Ads	29
CD of the Month	16
First National Eastern Insulator Meet	7
How to date your Brookfields	20
Know Your Collector	11
Letters to the Editor	21
Market News	27
Patent Information	13
Rate Page	26
Shows and Swaps	2
Title Page	1

CD for June is 409.

SHOWS AND SWAPS

This section is free of charge to anyone interested in having an announcement of their coming show published. We would be glad to print any information you would like to send to us. The guide for the calendar is as follows:

(B. S.) for bottle show.

(I. S.) for insulator show and swap

(+) indicates that more information is available on the following pages.

CALENDAR

MAY

- 6 (I. S.) Ojai, Calif. 3rd Annual at Ojai Elem. School.
6, 7 (I. S.) Muskogee, Okla. Civic Center 4th & Okmulgee.
7 (B. S.) (+) Lancaster, Pa., Guernsey Barn.
7 (B. S.) Stratford Conn., at American Legion, 2159 Main St.
13 (I. S.) (+) Westerville, Ohio. 2nd Annual Mid-West Insulator Show and Swap.
13, 14 (B. S. & I. S.) Hutchinson, Kans., Sports Arena.
13, 14 (B. S.) Missoula, Mont., County Fairgrounds.
13, 14 (B. S.) San Jose, Calif. Santa Clara County Fairgrounds.
14 (I. S.) (+) Middletown, New York. B. S. Enterprises.
16 (B. S.) St. Louis, Mo., Ramada Inn, S. W. 800 S. Highway Dr.
19, 20 (B. S.) Richmond, Va., 23222 Eastgate Shopping Center.
20, 21 (B. S.) Fort Wayne, Ind. Southgate Shopping Cntr.
20, 21 (I. S.) Dos Palos, Calif. 2nd Annual, Del Dale Hall.
21 (B. S.) (+) Clayton, N. J. South Jersey Heritage

Bottle & Glass Club.

- 21 (B. S.) Ithaca, N. Y. Finger Lakes B. C. Assoc.
27, 28 (B. S.) Hopkins, Minn., Hopkins House Motor
Hotel, Highway 7.

JUNE

- 4 (I. S.) Reelsville, Ind. 2nd Ins. Show Putman County
Fairgrounds.
10, 11 (I. S.) Coalinga, Calif.
11 (B. S. & I. S.) Middletown, Conn. Xavier High School.
17, 18 (B. S.) Birmingham, Ala.
24 (I. S.) (+) Vienna, Va., Eastern Insulator Club,
Volunteer Fire Dept.
24 (B. S.) Iron River, Mich. St. Agnes Church basement.

JULY

- 1, 2 (I. S.) Kansas City, Mo. President Hotel
1, 2 (B. S. & I. S.) (+) Portsmouth, Maine.

OCTOBER

- 1 (I. S.) Middletown, N. Y., B. S. Enterprises.
14, 15 (I. S.) (+) St. Charles, Ill. Kane County Fair-
grounds.

MAY 7

Pennsylvania Bottle Collector's Association Antique Bottle Show and Sale, Sunday, May 7, for 9 a.m. to 6 p.m. Show will be held in the heart of Penna. Dutch Country at the "Guernsey Barn", five miles east of Lancaster, Penna. on Route U.S. 30. Quite a few insulator stands will be there. Show information can be acquired by contacting Clyde O. Garber, Berlin Rd., New Oxford, Pa. (717) 624-4411.

MAY 13

The Mid-West Insulator Swap and Show will be held May 13, in the Grange Hall, Westerville, Ohio, 15 miles northeast of Columbus, off I.S. 270. A "Crown Jewels" ribbon will be awarded for the most interesting and unique display.

Tables before May 1, \$4; after \$5. For table reservation and camping information contact D.H. Bauman, 380 Circle Court, Westerville, Ohio 43081.

MAY 14

The 1972 Insulator Show and Trade Meet will be held on Sunday, May 14th in Fancher Davidge Park, Middletown, N. Y. 10940. The Meet will be held under large open sided shelters come rain or shine.

Each shelter contains 20-12 ft. tables for which a six foot table length reservation is \$3 and a 12 ft. table is \$6 including admission. Admission for all those without tables is \$.50. Table reservations should be sent as early as possible to insure a space.

Set up time is from 9 a.m. to 10 a.m. with general admission open at 10 a.m. Trophies will be awarded for the insulator displays that are the "Most Informative" and the "Best in Show". Door prizes will also be awarded.

Please have reservations in by May 6th.

MAY 21

South Jersey Heritage Bottle and Glass Club will be holding a show and sale at St. Catherine's Social Hall, North & Delsea Dr., Rt. 47, Clayton, N.J. For information contact Sam Baker, 1138 Lindberg Drive, Deptford, N.J. 08096.

JUNE 24

The Vienna Volunteer Fire Department, located at 400 Center St. South in Vienna, Va., has been reserved for the Eastern Insulator Club Swap Meet on June 24th.

The meet will be open to the public from 10 a.m. to 7 p.m. Cost per table for non-members, \$5; for table for members who wish to sell, \$3; members displaying only, free; visitors and non-displayers, \$.50, children under 12 free. Tables are banquet size, but are limited in number, so reservations should be made in advance with Davy Crockett, Club President, 5710 Belfast Lne., Springfield Va., 22150. Awards will be given to displayers in three categories, Beginners Glass, Advanced Glass and Ceramics; and for the most interesting or unique display, etc. Judging will be done by all in attendance. There will also be several door prize drawings. It should be noted that paid

tables receive free refreshments and that refreshment concessions will be available at the meet for others participating.

Start planning now to attend and get your reservations in early.

JULY 1 & 2

The New England Bottle Club will hold their show at the Portsmouth Senior High School gymnasium on July 1 and 2, 1972. This is to take the place of the annual summer show that has been so successful in Laconia, N.H. for the past few years.

As an added attraction the show is having the auction again this year on Saturday and extending the show to one additional day. There will be room for about 100 tables. All tables will be 8' x 2 1/2'. All tables must have covers. No reproductions will be allowed unless they are marked as new.

Anyone interested in attending the show may write: John W. Morgan, P.O. Box 24, Portsmouth, N.H. 03801 (603) 436-2545. For the auction write: Robert Heath, Union, Maine. (207) 785-4228.

OCTOBER 14 & 15

The first Annual Chicago Mid-West National Insulator "Jumbo" show will be held at Kane County Fairgrounds in St. Charles, Ill. (see ad in this issue). For reservations call (312) 766-3705 or write: Dick Augustyn, 650 South Harvard Ave., Addison, Ill 60101 or Larry Veneziano, 324 Hawthorne Dr., Bensenville, Ill. 60106.

FIRST NATIONAL EASTERN INSULATOR SHOW AND SWAP

The 1st National Eastern Insulator Show and Swap was held in Ithaca, New York, April 8 and 9. The meet was hosted by Brad and Nancy Cook. The results of their efforts was a show just short of 80 insulator dealers displaying, a good time by all, and the anticipation of everyone toward next years show.

CROSS ARMS was only able to attend the first day of the show. To you collectors who have never attended a show it is an experience not to be forgotten

We enjoy printing pictures of the different meets but due to space and realizing that we must also keep the book informative, we can only print a small portion. We were able to take single pictures of various rare insulators and intend to publish them as time and space permit in future issues.

On the following pages are pictures of a small portion of the dealers and their displays including the winners of the Gerald Brown Porcelain ribbons and the "Crown Jewels" Ribbons. Starting on page xx we have more pictures of the various displays at the meet.

As you will notice we are trying to follow our policy of showing the insulator display close up rather than a long distance picture in which no insulators are distinguishable.

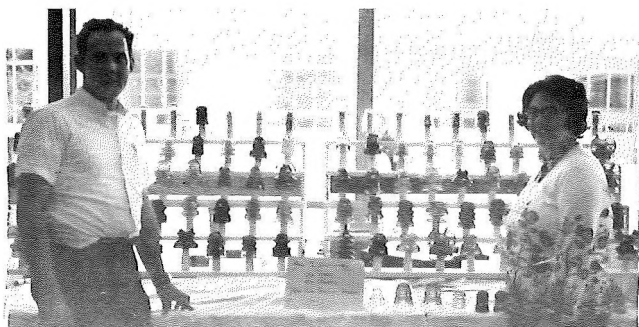

The hosts of
the 1st National
Eastern
Insulator Show,
Brad & Nancy
Cook.

Winners of
the best por-
celain. Mr. &
Mrs. Edgar
Smith.

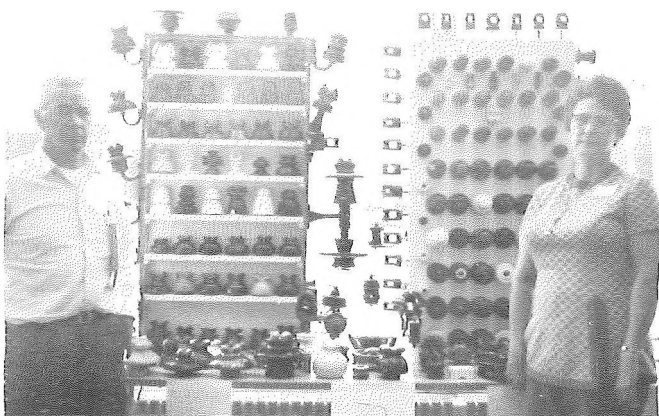

2nd place
porcelain
Ron &
Bonnie
LaSalle



Mrs. Audrey Stecher, the winner of the third place in Brown's best of Porcelain and winner of the Best in Show "Crown Jewels" ribbon.

Pages 23, 24 & 25 show more pictures of the Ithaca meet and some of the insulators on display there.

Your Editor and his better half with their first runner up "Crown Jewels" ribbon.

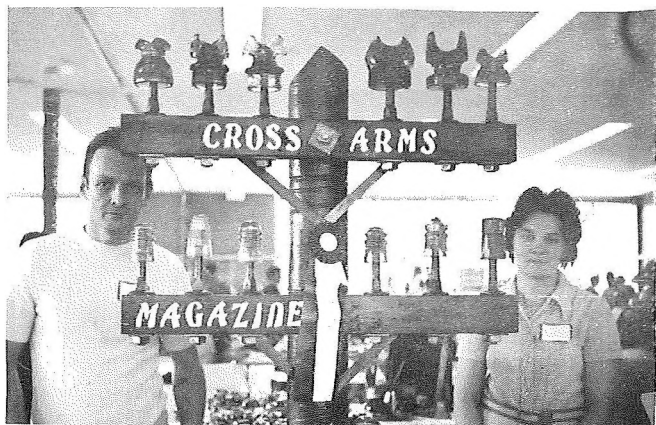

Ithaca Show, cont.

Ell Bennett of Milford, Conn.



James Robbins of Montgomery, Ala.



KNOW YOUR COLLECTOR

Our collector for the month of May, is Mr. Bill Cosner and his wife, Audene of New Hope, Pa. Audene has been collecting for about 12 years and she was joined by Bill about 3 years ago. Their collection is one of the best and largest around today.

Bill and Audene Cosner



left to right: Chester (4 lugs); CD 211 Brookfield no leak (both pieces, green); Elliott threadless (flintstone); CD 181 Hound-dog (aqua); Pluto (embossed Fisher).



left to right: Blob top (cobalt); Mulford & Biddle (cobalt); unembossed Tilson (amber); CD 733 W. Brookfield, (Cauvets Pat. 1865 threadless); CD 459 Boston Bottle Works (amber); rim embossed-M. T. Co. (green); CD 123 E. C. & M. Co. S. F. (cobalt); CD 740 unembossed Tilson (olive green); M. T. Co. rim, threadless (sapphire blue); CD 409 Harloe; no name threadless button top; Foster Brothers St. John C. F. 1858 (black glass); CD 723 Wade dots & dashes (aqua); CD 731 button top; CD 736 unembossed New York & Erie; CD 729 unembossed Mulford & Biddle.

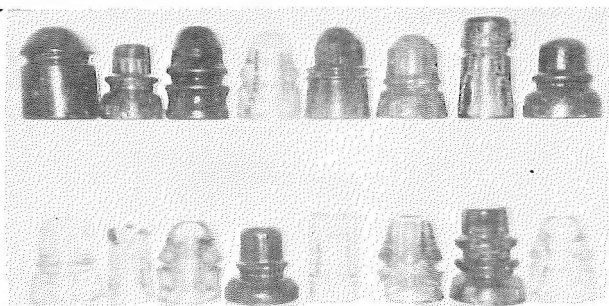

below left to right: CD 735 U. S. Tel Co. Chester, N. Y. on back, threadless; CD 734 McMicking, back: Victoria B. C. (aqua); CD 206 Castle top, round drips (lt. green); Lg. unembossed Bell; CD 718 no name threadless (deep Olive); CD 735 Mulford & Biddle, back: U. P. R. R. (aqua); CD 173 Brookfield on dome, flat top (green); CD 159 F. W. Gregory (aqua); CD 245 T-H 9200, back: Cable (aqua); CD? no name threadless (blue-green); CD 304 Lynchburg (181 on ear), back: made in U. S. A.; Oakmans Pat. (two slots) inner rim embossed (aqua).

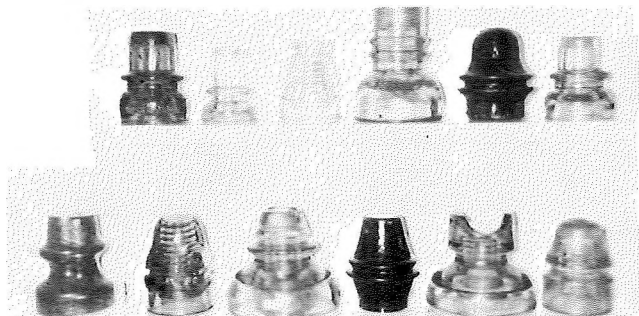

PATENT INFORMATION

These pages contain drawings of two insulators found in the patent office. The first patent is #183,865, and patented by David M. Reynolds of Post Deposit, Maryland. This invention was to provide an insulator for telegraph-wires, and other purposes, that would combine cheapness with efficiency, and obviate the necessity of using a "tie-wire".

It consisted of a glass peg screw-threaded at its upper end, adapted to be secured to the telegraph-pole, or wire support, in any suitable manner, combined with a glass nut or cap, between which the wire is firmly clamped and held in position.

"A" represents the body or peg of the insulator formed preferably of glass. The upper end of said peg is screw-threaded, and provided with a longitudinal central slot, "S", for the reception of the wire. "B" is the cap, formed also of glass, having the lower edge rounded off, and adapted to be screwed onto the peg and clamp the wire firmly. The peg "A" is rounded off or convexed at the lower extremity of the slot "S", so that when the cap is screwed down to its place the wire will be bent, and thus be prevented from slipping out of the insulator in case the telegraph-line should become broken.

Mr. Reynolds also states that the general form of the peg and cap may be changed, and the essential element of clamping the wire between the two parts, one screwing upon the other, may be preserved.

PAT. No.
183, 865

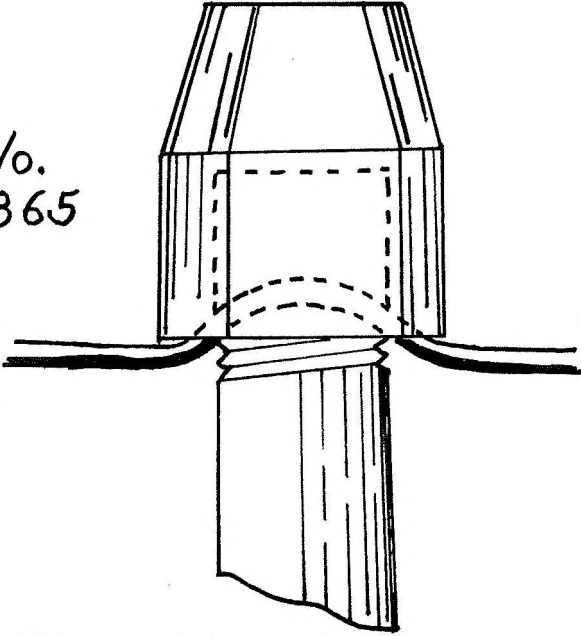

D.M. Reynolds

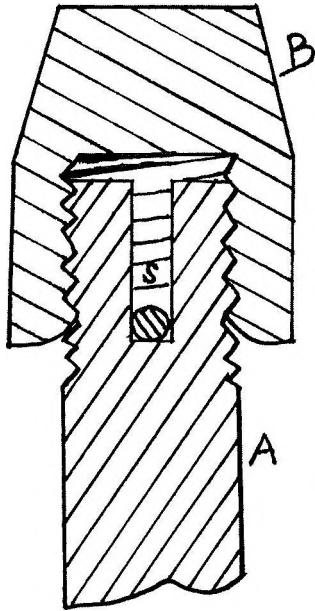

This insulator is a double petticoat side groove style. It is used mainly on power circuits and usually holds wires carrying 440 to 1200 volts.

Most of these insulators were made between 1920 and 1940. The glass is usually free from bubbles and impurities and to find a manufacturing defect in one is indeed uncommon.

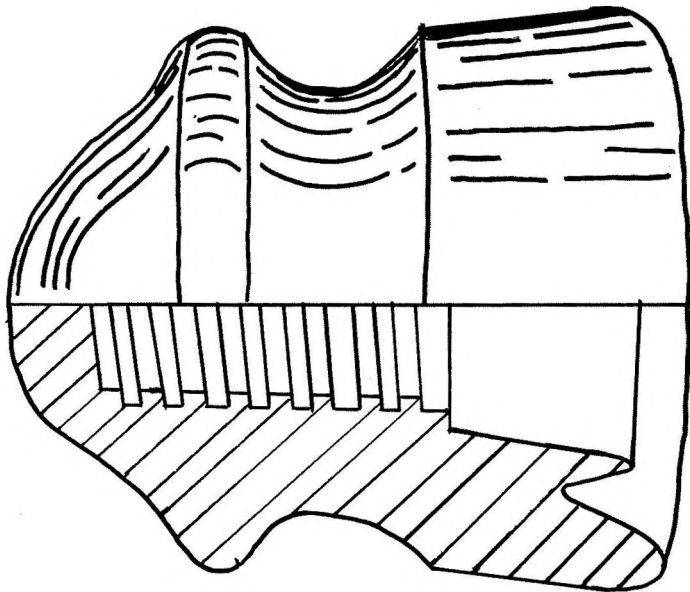

LIST OF EMBOSSINGS:

Front: Hemingray (small number and/ or dots above) MADE IN U. S. A.
Back: Small number over D-510.

Front: Small numbers and dots above Hemingray- MADE IN U. S. A.
Back: Number above D-510. Smooth base.

Front: Hemingray- MADE IN U. S. A.
Back D-510. Smooth base.

Front: Reg. U. S. PAT. OFF. Small embossing above LOWEX D-510
Back: Numbers above Hemingray- MADE IN U. S. A. Smooth base.

Front: Whitall Tatum-No. 11. Smooth base.

This patent was invented by Robert A. Cunningham and David F. Crowell, of Zanesville, Ohio, and was issued a patent number #184,509.

In the accompanying drawing, Figure 1 represents a top view, and Fig. 2 a side view, partly in section.

The invention consists in constructing the head of the insulator with a transverse groove which divides the head into two sections, the convex section of which is made higher than the other, so that the wire may be bent around the same, and kinked with a curve corresponding to the transverse groove.

In the drawing, "A" represents an insulator, which is made entirely of glass, the shank "B" being provided with a screw-thread to be directly screwed into the hole bored into the cross beam to dispense thereby with the wooden pin, upon which most insulators are placed.

They claimed this construction would greatly facilitate the putting up of wires, especially those of small diameters, as it rendered unnecessary the clumsy and inconvenient use of tongs for kinking the wire. They further claimed that the insulator could be used in any position, and would be very convenient where the wires have to be turned in different directions and at right angles, as in turning the corners of streets, etc.

They described their insulator as a telegraphic insulator having its head divided by a groove into a concave section having projecting shoulders "d", and a convex section of greater height than the said concave section.

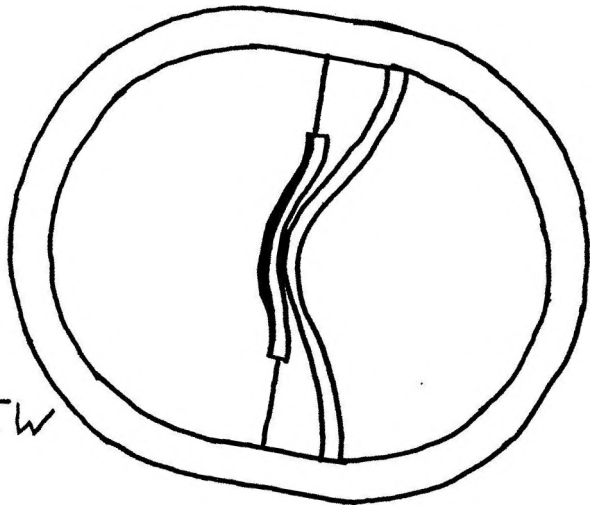

TOP VIEW

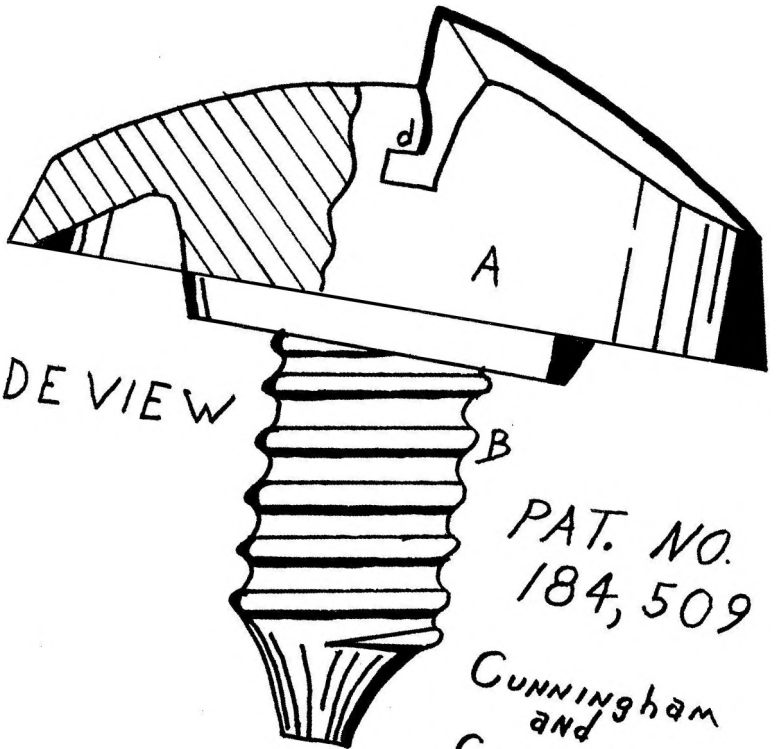

SIDE VIEW

PAT. NO.
184,509

Cunningham
and
Crowell

HOW TO DATE YOUR BROOKFIELDS
(courtesy of M. Milholland)

1868 to 1882- Embossed address: 55 Fulton St.
1882 to 1890- Embossed address: 45 Cliff St.
1890 to 1897- Embossed address: 81 or 83 Fulton St.
189? to 1903- Embossed on skirt: Front: W. Brook-
field
Back: New York

Mr. William Brookfield died in 1903 and the W. was then dropped from Brookfield. After that the words New York were also dropped. In 1920, the company went out of business.

Arrived to late to classify

Mid-Atlantic Collectors Association is now in the process of organizing a show and swap meet. Scheduled for August 6th, 9 a. m. to 6 p. m.

It will be held at the Bergenfield Recreation Center, 47 Legion Drive, Bergenfield, New Jersey.

The man in charge of the show is Jerry Wagner, 15 N. Demarest Ave., Bergenfield, New Jersey. Phone: (201) 384-5213.

Approximately 30 tables at present. Reservations \$5.00 per table. Doors open for table holders at 8 a. m. Admission for general public 75¢.

Send Jerry your check as soon as possible. We will be printing more information as it becomes available.

LETTERS TO THE EDITOR

Dear Mr. Garrity:

My name is Chuck Riggs. I'm sending you two pictures of an insulator, one picture shows the whole insulator, the other showing the base where PAT' is embossed. I would be very pleased to have this appear in the CROSS ARMS. The dimensions are: height 3 1/2" base, 2 1/2". The photo's were taken by Bill Brown of Homer, N. Y.

Thank you. Chuck & Ronnie Riggs.

* * * * *

Here is a picture of Chuck's insulator.

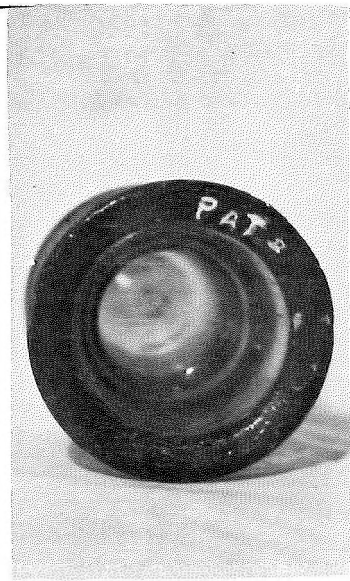

Dear Jim,

I have recently found an insulator not listed in any of my books and so far haven't found any one else with one

in their collection. It is a Lynchburg triple petti-
coat, CD 281, with drip points and a yellow green color.
The embossing is as follows:

Front: 
LYNCHBURG
Rear: MADE IN USA
Across top of the dome NO. 180

My sincere wishes for success with your new venture.

Sincerely, Francis Fekel

* * * * *

Dear Francis,

Thanks so much for your letter. I'm sure the readers
like to hear of new finds such as yours. Anyone with
any more information we would be glad to hear from
you.

Dear Jim,

I thought you would like to get a look at my "Franken-
stein" (hold it upside down and you'll see what I mean).
The color is a light green. I took the shot with a CD 196
H.G. Pagoda for comparison size.

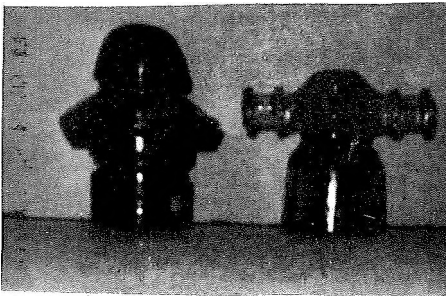

Bob Bretschneider

Embossing:

Front: L'Electro
VERRE

Back: LB 22

it also has an inner
skirt.

Ithaca Show, cont.

Howard Makela of South Lansing, N. Y.



Dick Baright of Poughkeepsie, N. Y.

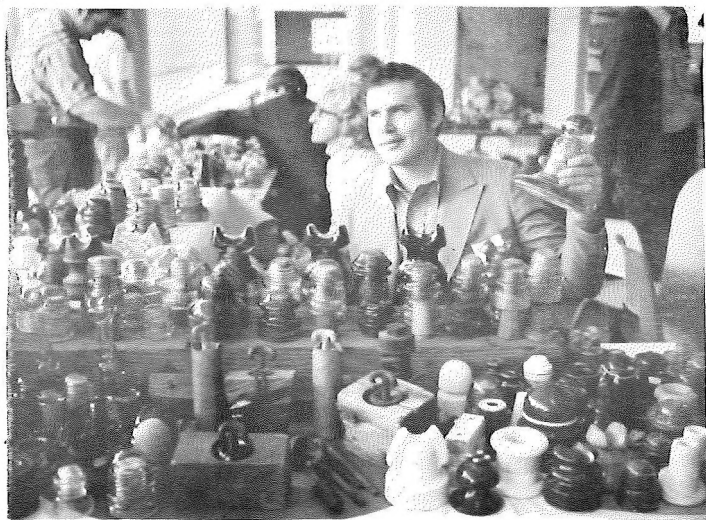

Ithaca Show, cont.

John Morgan of Portsmouth, N. H.



Below Steve Freedman of Wallingford, Conn.

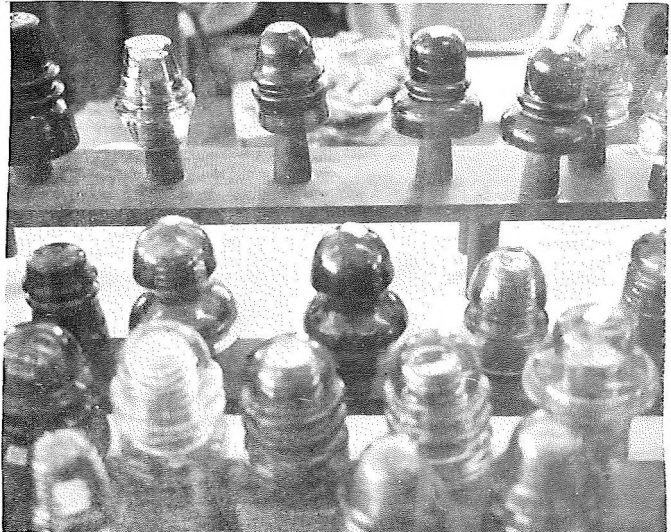

Ithaca Show, cont.

Background shows some of the trading action
Foreground Mrs. Ed Cook of Oxford, Mass.



a nice collection of
rare insulators belonging to John
Hewitt of Stockton,
N. J.

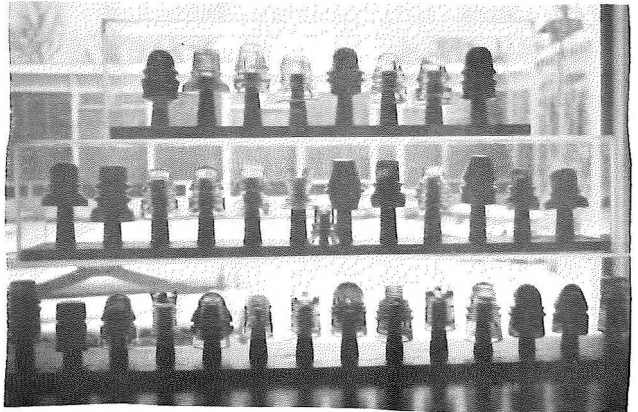

ADVERTISING RATES are as follows:

Display ads:

1/4 page - \$5.00 per issue
* \$12.00 per three issues

1/2 page - \$10.00 per issue
* \$25.00 per three issues

Full page - \$18.00 per issue
* \$45.00 per three issues

Classified Advertising:

\$.05 per word (minimum \$1.00). The closing date for material will be the 10th of the month preceding the month of the issue.

Ads received too late for the deadline will be run in the next issue.

We accept no responsibility for errors except to reprint the incorrect portion of the ad in a later edition. We will do our best to make sure all advertisers are reliable but cannot be held responsible for the validity of their copy nor for their performance.

Send black and white prints or copies as they will reproduce with more satisfactory results. All material will be returned to the sender if specified, all other material becomes the property of CROSS ARMS.

*This is a slight change from our original price list.

MARKET NEWS

INSULATOR HISTORY

There is a book now available to the insulator collector that has a collection of insulator patents copied directly from the files of the U. S. Patent Office. The information shows patents issued from 1851 to 1885.

This book is a must for all serious collectors. It gives exact patent histories and drawings in chronological order of 166 different insulator patents. It has all telegraph patents and most lightening patents issued during that period.

A lot of time and effort was put into this book and I compliment the compilers, Aubrey and Penelope Branham, on their efforts.

The book is reasonably priced at \$10.00 and anyone wanting to purchase a copy can contact Mr. & Mrs. Branham. Their mailing address is 410 Hale St., Pennington, N. J. (609) 737-2338.

PRIVATE ISSUE

At the 1st National Eastern Insulator show and swap meet in Ithaca, N. Y., I was able to study first hand the #2 Columbia private issue put out by Mr. Larry Veneziano.

My fears about it being mistaken as a true threadless insulator were unfounded. The insulator is the same dimensions as the No. 2 Columbia and it has no threads.

The glass, color, clarity and back embossing show immediately that this insulator is a replica. I class this insulator as a collectors item and put it in the same category as the threadless "Human Service" put out by Imperial Glass Co.

Mr. Veneziano has assured me that the mold will be broken after the 1,000 piece lot is made.

Going Prices of Insulators

First National Insulator Meet

Manufacturer	CD	Condition	Color	Prices
Hemi-WU-5	125	mint	aqua	9-12
Hemi-SB	428	mint	clear	25
Chicago	135	mint	blue	75
Hemi-25	175	mint	aqua	10-15
the Castle	206	mint	blue	225
Duquesne peak top	---	mint	ice aqua	18-30
PLW	462	mint	aqua	60-65

A note from Mr. Marion Milholland: His current book "MOST ABOUT GLASS INSULATORS" now being sold will not be reprinted. His coming new book will contain the same insulators plus more but will not have some of the extra information. So anyone interested in ordering place your order now.

CLASSIFIED ADS

INSULATORS FOR SALE - - Hemingray 25, aqua mint, \$12.50; Hemingray 55, aqua mint, \$7.00; Hemingray D-510, amber, \$8.00; CD 205 Brookfields inner skirt chip, \$10.00; Gayner 530 vnm, \$20.00; Lynchburg 530, vnm \$25.00; colored Mickey Mouses, blue (not dated) nm \$12.50, green dated nm \$15.00; rare wide groove colored Mickey Mouse, mint, \$25 blue; 511 A Armstrong, red amber, \$6.00; Green somberos, metal on (French) \$5.00 each; Fog Bowl porcelain gray, mint, \$6.00; blue dated manhattan vnm, \$70.00; blue non dated manhattan, vnm \$60.00; large Chambers, mint \$200.00 many, many more-- Threadless Wanted. All above plus postage. L. Veneziano CA, 8310 Center St., Rivergrove, IL 60171.

"WHILE THEY LAST" Surge-CD 100, \$2.00 each for orders of 2 or more-Post paid; Whitall Tatum #1 CD 154-purple, \$2.50 each, plus postage. Marion Milholland CA, Rt. #2, Box 368, Sequim, Washington 98382.

FOR SALE: mint or vnm unless stated. CD 156 postal telegraph co. base embossed (sm. chip on inner skirt), aqua, \$45; CD 252 Knowles #2 cable dated with prism (aqua) \$25; CD 259 Cable helmet, aqua, \$15; CD 175 Hemingray #25 (clear & lt aqua) \$15; CD 188 (aqua) \$12; CD 234 Pyrex (carnival) \$10; CD 235 Pyrex (carnival) \$10; CD 202 Locke #14 (aqua) (inner skirt chip) \$10; CD 252 Hemingray 62 (aqua) \$8; CD 219 Hemingray-Lowex #660 (amber) \$12; CD 190/91 embossed B (aqua) \$12; CD 190/91 Hemingray #50 (aqua) \$10; CD 121 C. D. & P Tel Co. (aqua) \$4; CD 121 crown embossed

Am. Tel & Tel Co. (aqua) \$8; postage & ins. extra.
Lists welcome, Edward Szymala CA, 217 Spruce St.,
Cresson, Pa. 16630.

" MILHOLLANDS "

" MOST ABOUT GLASS INSULATORS "

1500 Glass insulators described. Full size photo's and machine drawings. Consolidated numbers for threaded and "threadless" insulators, for the first time. You will like this 248 page-hard cover book. We are proud to offer at \$10.00 Post Paid, including the 1972 price list. (Favorite Milholland #2 Book still \$4.50 P.P. including 1972 Price List.) Order from Dealer "OR" Direct from, Marion Milholland R. #2, Box 368, Sequim Wash. 98382

"Wanted for Private Collection"-- old weathervanes, arrows with glass inserts, animals, lighting rod balls. Please send good description and your best price.
L. Veneziano CA, 8310 Center St., Rivergrove, Il. 60171

Will buy good threadless insulators. Also want rare unusual colors of helmets, Mickey Mouse types. Have variety of better to rare insulators to sell, none common. SASE for reply. Russell Sprague CA, 8800 Greens Lane, Randallstown, Md. 21133.

FOR SALE: mint or vnm unless stated. CD 190/91 PRR, aqua--\$150; CD 131 threadless, aqua--\$95; CD 462 P. L. W., aqua--\$60; CD 254 #3 cable, aqua--\$35- chip on outer skirt--\$20; CD 168 Whitall Tatum #11 (sm. chip inner skirt)--\$30; CD 178 Santa Ana, aqua--\$20; CD 297 Locke #16, aqua--\$20; CD 120 Pat. Dec. 19, 1871 aqua--\$20; CD 121 U. S. Tel Co., deep green (chip on side)--\$15; CD 121 Duquesne, aqua--\$15; unem-

bossed--\$5; CD 102 Hawley, aqua--\$12; CD 145 Dated E. R., aqua--\$8; CD 296 Locke #20, aqua--\$10-3 for \$25--unembossed #20--\$5. List welcome. Postage and insurance extra. Ferd Huber CA, 385 Allendale Rd., King of Prussia, PA 19406 (215) 265-6432.

FOR SALE: Reducing my collection at cost. Large Chambers, Bell, Baby, Dog Ears or Pluto, Manhattan, Ramshorns, Glass and Porcelain mines, Porcelain cables, Transposition, few Ohio Bell Commemorative, Lynchburg 181 CD 306, mint; Hem. 19 carnival, cobalt 19 and H. G. mint, E14B opalence, Ranson Patent porcelain U-183-1903. Red glass lightning ball, white porcelain ball \$15.00 ea. Electric blue bell telephone paperweight. Small white grooved porcelain strains found with above Ramshorns \$5.00 ea. mint or 6 minor flakes for \$20.00. Brookfield SCA New York signal. Brookfield dark amber pony size. Threadless CD 728, no embossing, bubbles and greenish streak. Iron insulator, damaged Glass Cutter \$20.00, SCA Bullet no embossing. Many others, write wants. Will trade any or all for rare one I need. Post paid and satisfaction. Have no lists, SASE for price and description. Forrest Jones, Rt. 3, New Carlisle, Ohio 45344.

"INSULATORS WANTED:" - Paying top cash prices for rare insulators. Also have many for trade. Please write wants. Please send good description and best price first letter. Especially looking for glass Harloe, Boston Bottle Works, Paisley, all Threadless. Send Larry Veneziano CA, 8310 Center St., Rivergrove, Ill. 60171 Ph. (312) 456-8496.

1st ANNUAL

CHICAGO MIDWEST NATIONAL INSULATOR
SHOW
OCTOBER 14 & 15

Kane County Fairgrounds

Rt. 64 St. Charles, Ill.

Outside set ups
available
Show Ribbons
Awards
Food Served
Armed Guard
Free Dealer
set up
FRI NOON
Bottles Welcome

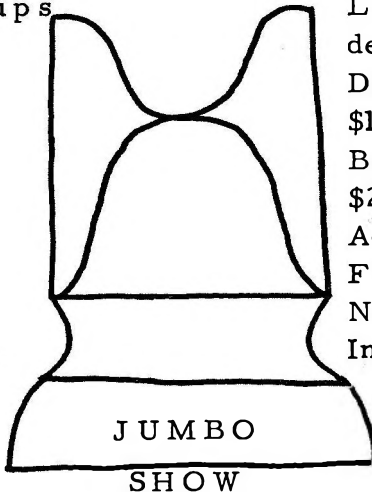

Large Building
dealer collector
Display Tables
\$10.00 per day.
Booth (3 tables)
\$25.00 per day.
Admission to
Fairgrounds \$1
No add. admission
In - or - out

For Reservations
Phone (312) 766-3705

Dick Augustyn
640 S. Harvard Ave.
Addison, Ill.
60101

Larry Veneziano
324 Hawthorne Dr.
Bensenville, Ill.
60106

**CROSS
ARMS**

367 Signal Hill Road
King of Prussia, Pa.
19406

RETURN POSTAGE GUARANTEED

FIRST CLASS

John R. Snyder
244 Waggoder Blvd.
Toledo, OH 43612

