



DRIP POINTS

MAGAZINE FOR INSULATOR COLLECTORS

OCTOBER 2022 • Vol. 50, No. 5

GETTYSBURG NATIONAL

2022



ANOTHER NEW DISCOVERY
Jeff Katchko's Harloe No.3.E

CD 206.7

CELEBRATING 50 YEARS



**THREADLESS INSULATORS WANTED FOR MY COLLECTION
& RESEARCH. WILL PAY TOP DOLLAR!**

COLLECTING INSULATORS SINCE 1967! I AM OLD.

DARIO DIMARE

**318 MAIN STREET, NORTHBOROUGH, MA 01532
617-306-2420 DARIO@DARIODESIGNS.COM**

In This Issue *&* DRIP POINTS

🏠 NIA Board & Committee Articles *🏠*

President	Darryl Wagner.....	5-12
Drip Points Managing Editor	Doug Rusher.....	14
Commemorative Coordinator	Margaret Wagner.....	13
Western Region VP	Roger Ziesak.....	14
Eastern Region VP.....	Gus Stafford.....	15-16

🏠 Features & Articles *🏠*

Gettysburg National.....	by Gus Stafford & Mary Ann Pike.....	22-37
Logan National Update.....	by Don Briel	39
Collector Threads Bill Rohde.....	by Mike Green.....	40-45
Dixie Jewels Summer Swap.....	by Mike Herron & Bill Haley.....	46-47
Jefferson State Bend Ore Swap Meet.....	by Howard Banks.....	48
Did You Know?.....	by Don Briel.....	50-51
2022 Cayucos Insulator Show.....	by Bob Merzoian.....	52-53
International Insulator Show.....	by James Bancroft & Stefan Haunstetter.....	54-56
CD 120 Rd No 156417.....	by Michel Brunet.....	57
Insulator Spotlight CD286 Locke Flat Top Pt 2.....	by Doug Rusher.....	58-60
Hawkeye Swap Meet.....	by Bill Snell.....	61
EBBW Vale Coal Co Power Line Hunt Pt2.....	by Jack Nesbit	62-64
Upcoming Events.....	by NIA Staff.....	66-67

🏠 NIA Information & Forms *🏠*

Drip Points Magazine Ad Rates and Specifications	74
NIA Donors & Sponsors.....	76-77
NIA 50Year Members.....	77
NIA Affiliated Clubs.....	78
NIA Membership Application & Renewal Form	79
NIA Merchandise	80-81
NIA Contact Information	82



🏠 About the Cover *🏠*

2022 Gettysburg National Coverage

This month's cover is dedicated to the outstanding National Insulator Association's National in Gettysburg PA. Congrats to Gus and his crew. See Jeff Katchko's amazing new find the Harlow CD 206.7 Power Claw, See Dario DeMare's Outstanding display of threadless (this is Dario's First time displaying at a show.)

Would you like to have your photo or artwork featured on the cover of Drip Points Magazine? Contact the Editors at drippoints@nia.org.

Disclaimer: The opinions expressed in any article submitted to the NIA and printed, presented, or reproduced in Drip Points are those of the author(s) of such article. Articles printed, presented, or reproduced in Drip Points, and any opinions expressed therein, do not purport to reflect the opinions or views of the NIA, its Members, the NIA Leadership, or the Drip Points Editorial Staff.

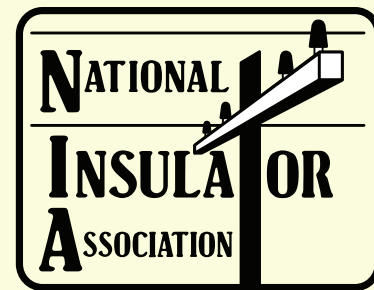

Established in 1973, the National Insulator Association is a 501(c)(3) charitable nonprofit organization. Visit us on the web at www.nia.org.

About Drip Points Magazine

Drip Points Magazine is published bi-monthly to all active members of the National Insulator Association.

To purchase ad space or submit content, please email drippoints@nia.org, call (406) 461-7341, or write to: Doug Rusher, 3370 Chance Ct., Helena, MT 59602.

Publishing Schedule

Issue	#	Deadline	Mailing
February	1	Jan. 10	Feb. 1
April	2	Mar. 10	Apr. 1
June	3	May 10	Jun. 1
August	4	Jul. 10	Aug. 1
October	5	Sep. 10	Oct. 1
December	6	Nov. 10	Dec. 1

What's in a Name?

"Drip Points" is named after the feature seen on many insulators produced from the 1890s through the 1950s. Drip points are the bumpy protrusions around the base of an insulator. Their purpose was to help draw water off of the insulator.

Copyright © 2022 National Insulator Association. All rights reserved. No part of this publication may be reproduced, stored, transmitted, or disseminated in any form or by any means without prior written permission from the National Insulator Association. Magazine designed by Doug Rusher.



WANTED

My Goal is to form a complete
collection of CD styles



**IF YOU ARE SELLING, PLEASE GIVE ME THE CHANCE
TO TOP YOUR HIGHEST OFFER!**

The insulators I need are listed by their CD number in the following columns.
Numbers in regular typeface are North American CD's Numbers in **Red** are Foreign CD's

North American		Foreign		Threadless		Odds & Ends	
10	136.5	334	404.2	570	656.8	700.4	1025
12	139.8	343	404.5	571.7	669.5	723.5	1034
25	148	343.5	405.5	583	669.8	724.5	1035
28	181.5	350.3	414	586.5	687.1	728.5	1040
28.5	192.1	365	445.4	591		732.4	1045
29.5	244.5	370.3	451.5	595		784	1052.5
30	245-cup	374	451.6	607			1066.5
30.5	303.5	377.7	480	607.5			1100
33	313	378.4	533	610.2			1102.3
45	313.1	379.3	537.4	613			1102.5
61		380.1	563.2	625.5			1103
109.7		404	567.5	653.5			1127



THESE YUMMIES ARE LOOKING FOR MORE NEW FRIENDS

FOR CASH CONTACT:

Tommy Bolack 3901 Bloomfield Hwy. Farmington, NM 87401 (505) 325-7873

NIA PRESIDENT

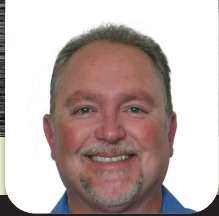

DARRYL WAGNER * NIA #8671

Fellow members,

If you did not make the Gettysburg National, you missed another great show. A new CD, couple of great seminars and of course the opportunity to catch up with friends. We also have our own You-Tube channel now, with a couple of videos already posted. See this and much more in this issue of Drip Points.

This year's NIA Board of Directors meeting had us discussing current issues as well as planning for the future of the NIA. The biggest issue discussed was the cost of publishing our first-class magazine, Drip Points. Over the last couple of years, various costs for the magazine have been increasing. The first issue is the increase in paper costs. This may have been precipitated by COVID, but it is an on-going issue. Also, beginning the first of the year, our publisher is having to charge tax on the magazine. Then we look at how our editorial staff has increased to keep up with Drip Points, which means an increase in software costs. This has also increased because of the printing of the Insulator Collectors Directory. Given the increases in these expenses, the cost of 6 issues of Drip Points is now more than one year's printed membership. With that in mind, we have passed new membership rates effective 1/1/2023. They are as follows:

Electronic	\$35.00	Canadian Electronic	\$35.00
Printed	\$58.00	Printed	\$75.00
Both options	\$65.00	Both options	\$82.00
Junior Both	\$10.00	Other Countries	
Club Electronic	\$50.00	Electronic	\$35.00
Club Printed	\$70.00	Printed	\$78.00
		Both options	\$85.00



With these changes, along with our donations, the NIA will be able to continue and to improve Drip Points and further other projects for our hobby. If anyone has questions regarding these changes, please feel free to contact me or any of the Board of Directors.

The NIA's function is to serve and educate our members and the hobby. We are successful because of the support and contributions of our members. The Board and I thank you for that.

Another change that will be effective with the coming year's membership renewals, is a change in the coupon given upon membership renewal. The use of this coupon has declined over the past few years and we looked at what we might do with it. Due to the NIA's 501(c)3 status, the Board felt that paying out money to other individuals, or organizations, might not be the best way for the NIA to utilize this coupon. We therefore decided to change it to be used for the purchase of NIA Logo products. It is also being increased to a \$5 coupon that can be used once per year. Watch for your membership renewal to see the coupon.

Another thing I am very excited about is a new way to use something you probably do very often, see Amazon Smiles on Page 10

To acknowledge members contributions, several new awards have been created, some given at the banquet in Gettysburg. The first are the new Drip Points Category Awards. See details on page 11.

Another award that we have initiated is a Regional Service Award, which the Regional Vice Presidents will award as they determine. This is meant to acknowledge those that might not be Nationally recognized, but still contribute to their region. There may be one award per region per year.

The other new award is our 50 Year Recognition Award. I would like to personally thank those members that have reached this level for their contributions to the hobby and continued support of the NIA. See more on page 12

We are still working on a traveling museum display for insulators. Brian Riecker has graciously built a mock cabinet for displays that we had on a table at Gettysburg. We have had some insulators donated over the last year. Some of these may be used in the display(s) and some of them may be sold to raise money for the cabinets. You can donate insulators (glass, porcelain or other) or money for this project. We are wanting to build one cabinet to be used in the Eastern Region first. If this is well received, then we will continue to build a cabinet for the Central and Western Regions.

Since I was remiss at the National Banquet in recognizing some of our award winners, please read the information for our Outstanding Service, Lifetime Membership and Hall of Fame awards. The Board and the NIA thanks these recipients for their contributions to the NIA and the Hobby.

As always, I am here to serve the NIA and its members. If you have any questions, suggestions or want to discuss something, please reach out to me.

Happy collecting!
Darryl Wagner



NIA PRESIDENT

DARRYL WAGNER * NIA #8671

NIA OUTSTANDING SERVICE AWARD

Nominee: Christian Willis

NIA#: 5185

Service to the NIA: Christian is currently serving as Information Director, Board Member, and Drip Points Assistant Editor. He recently stepped down as Drip Points Managing Editor after several years in that position and will be stepping down as Information Director in July. He is still very active in the NIA and the hobby.

Show(s) Hosted: Research, Articles, etc: Christian has had at least one article, sometimes multiple articles, in every Drip Points since being involved with its production. He is very knowledgeable on Hemingray products.

Other Major Contributions to the Hobby: Created a web site for Hemingray insulator information: <https://www.hemingray.info> Christian is a wealth of information on Hemingray insulators and a frequently contributes information for the North American Glass Insulators - Price Guide.

Miscellaneous Comments: NIA member in good standing since 1992. When the last Drip Points editor abruptly resigned, Christian took over without missing a beat in delivery the next Drip Points and everyone since that time.



NIA OUTSTANDING SERVICE AWARD

Nominee: Ron Yuhas

NIA#:1993

Service to the NIA: Had been Western Regional Vice President

Show(s) Hosted: Co-hosted Western Regional Show(2019) and hosts The Big Sky Show every year

Research, Articles, etc: Has done a lot of research on early Montana power lines and helped gather information on the two Cochrane lines that were here in Montana

Other Major Contributions to the Hobby: Has hosted the Big Sky Show for the last 10 years, He has mentored a lot of new collectors and has also helped fellow collectors with power insulator questions and history.

Miscellaneous Comments: I have known Ron since we were both in college (40 years) and we have been like brothers every since. I have seen him give a new collector a Muncie or a pyrex power piece to get them started in the hobby, he Hosts the Big Sky Insulator Show every year and Ron and Peg open up their home on Friday night for a get together so folks can view his collection and do a show and tell and they furnish drinks and Pizza for everyone. His knowledge of power insulators is 2nd to none and I feel he really deserves this award, he also served as Western Regional Vice President.





NIA LIFETIME MEMBERSHIP AWARD

The NIA Lifetime Membership Award is the highest honor that can be given to a fellow hobbyist. Recipients include NIA members who have donated significant portions of their lives for the betterment of collecting. The effort taken to recognize those who have given hundreds or thousands of hours and/or dollars to the hobby should not be taken lightly. Lifetime Membership is for a couple, as the spouse is often involved, or at least is very supportive of the primary person being nominated. In some cases, the spouse is also involved in the hobby in a formal capacity and, in that case, the contributions of both people should be noted. The following form is designed to assist in documenting the cumulative contributions of NIA members to the insulator-collecting hobby in order to identify those most deserving of the "Lifetime Member" award. If you aren't sure about your nominee's qualifications and contributions ask those who know the person best such as friends, collecting partners, and, discreetly, the nominee him/herself. A thorough evaluation ensures that the esteem of the award is maintained and the efforts of those most deserving are not overlooked. A simple number will suffice for some of the categories that follow. Please indicate where the number is an estimate or approximation. In others, examples should be listed. Use additional pages for comments where needed. This nomination form will remain on file with the NIA for future consideration should the nominee not be selected immediately for recognition. Thank you for taking the time to recognize the most substantial contributors to the hobby. Please return this form to the Awards and Recognition Committee Chairman.

NAME(S): Don and Jeanne Briel

NIA #7218 & #7595

Number of years as NIA member: 23 (Don) 21 (Jeanne)

Number of years in the hobby: 15+ years

NIA OFFICES HELD (Board of Directors and Committee Chairs followed by number of years of service; also note any special contributions or accomplishments while in office):

DON:

1. NIA President (2 years)
2. NIA Membership Director (9 years)
3. NIA Event Committee Chair (2 years)
4. NIA Rules & Procedures Chair (current)
5. Outstanding Service 2018
6. Presidents award (2) -- 2014 & 1017

JEANNE

1. Scholarship Committee chair (4 years)
2. Presidents award 2020

NIA SHOWS HOSTED:

Nationals: 2020 & 2023

Local (Sanctioned): Several Logan Utah shows

APPROXIMATE NUMBER OF NATIONAL AND REGIONAL SHOWS ATTENDED: ~20 shows

DISPLAYS PRESENTED AT SHOWS:

National: About nine (many educational displays targeted at newer collectors)

Regional: One or two

Local: Numerous

BOOKS, PUBLICATIONS, RESEARCH ARTICLES WRITTEN:

- North American Glass Insulator Price Guide – 2011
- Full update "What are Insulators" – 2014
- North American Glass Insulator Price Guide – 2015
- North American Glass Insulator Price Guide – 2019



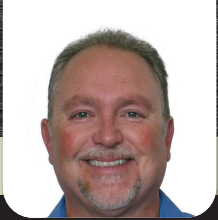

NIA PRESIDENT

DARRYL WAGNER * NIA #8671

NIA LIFETIME MEMBERSHIP AWARD CON'T

Don and Jeanne Con't

OTHER WRITINGS: (C.J., Rainbow Riders, Cross-arms, newspaper, internet and other articles prepared; generalize scope and type of contributions)

- 2020 Drip Points article "Where's the fun in collecting insulators?"
- A series of articles in both 2021 & 2022 Drip Points "Do You Know?" with information for newer collectors.
- Many Drip Points contributions while Don was the Membership Director, President, and Events Committee Chair.

SPECIAL PROJECTS OR CONTRIBUTIONS TO THE NIA OR HOBBY: (library book donor, museum donations, speeches to community groups, displays at libraries, other efforts to educate, etc.)

- Don has been an ambassador for the hobby supporting the NIA at many shows and on-line.
- Don has worked closely with Dario Dimare on the CD assignments and getting updated line drawings for the variants within a CD.
- Don has spent numerous hours validating EIN listings within the Price Guide as well as gathering hobby-wide data on new listings and accurate prices.

DEALER CONTRIBUTIONS: (Number of years, shows attended- especially long distances from home, etc.) Both Don & Jeanne have been long time attendees of the National, Regional and local shows, but also other major hobby shows such as Springfield, OH. They typically have a table at each show and always provide information on the NIA as well as general educational data.

MISCELANIOUS COMMENTS:

I feel the level of support Don and Jeanne have given both the NIA and the hobby at large is exemplary and has been maintained for over a decade!

NOMINEE'S NAME(S): **Richard Baldwin & Bernadette Baldwin (Rick and Berny Baldwin)**

NIA#: Rick - 336 Berny - 3530

Number of years as NIA member: 50 (Rick) Note: Charter Member, 50th Anniversary in the NIA

Number of years in the hobby: 50 (Rick)

NIA OFFICES HELD (Board of Directors and Committee Chairs followed by number of years of service; also note any special contributions or accomplishments while in office):

1. NIA Show Standards Committee Chairman (Awards and Recognition) 1988-1994 (6 years)
2. Central Region VP, 1994-1996 (2 years)
3. NIA President, 1996-1998 (2 years)
4. NIA First Past President, 1998-2000 (2 years)
5. NIA Second Past President, 2000-2002 (2 years)

LOCAL CLUB OFFICES HELD (Including any special contributions to local clubs):

1. Western Reserve Insulator Club VP, 2016 to present (6 years)
2. Western New York Insulator Club President, ("for several years in the 1970's)
3. Assistance with Central Regional on Show Host Committee in 2001, 2002 and 2008
4. Assistance with NIA National on Show Host Committee in 2004
5. Assistance with ICA Expo in Washington, PA in 2016 and 2017, set up & show coordination

NIA SHOWS HOSTED:

Nationals: On Show Host Committee for 2004 National

Regionals: On Show Host Committee for 2001, 2002 and 2008 Central Regional Shows



NIA PRESIDENT

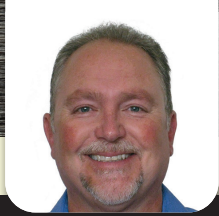

DARRYL WAGNER * NIA #8671

APPROXIMATE NUMBER OF NATIONAL AND REGIONAL SHOWS ATTENDED:
Estimate more than 20

DISPLAYS PRESENTED AT SHOWS:

National: estimated 1 or more
Regional: 3 or more
Local: 1 or more

BOOKS, PUBLICATIONS, RESEARCH ARTICLES WRITTEN:

- Decolorizing Glass with Manganese by Rick Baldwin, Crown Jewels of the Wire, July 1985, pg. 23
- Chemical Safety Awareness When Cleaning Glass Collectibles by Rick Baldwin

OTHER WRITINGS: (C.J., Rainbow Riders, Cross-arms, newspaper, internet and other articles prepared; generalize scope and type of contributions)

- The Power of Wishful Thinking by Rick Baldwin, Crown Jewels of the Wire, December 1987, pg.26
- Drip Points Awards Reviews, CVP Articles, and NIA President Articles, ca. 1989-1998 (go to NIA.org website, go to 'Hobby' tab and select "Drip Points Magazine Achieve" to view various Drip Point issues for articles and columns by Rick Baldwin over this time period)
- Drip Points WRIC Show Reports, ca. 2020-2022

SPECIAL PROJECTS OR CONTRIBUTIONS TO THE NIA OR HOBBY: (library book donor, museum donations, speeches to community groups, displays at libraries, other efforts to educate, etc.)

- Seminar Presentation: Altered Insulators: Research on what determines an insulator color and what can change or alter it. June 25, 2016 at the ICA Expo, Washington, PA
- Seminar Presentation: Cleaning of Insulators: Chemical Safety. June 24, 2017 ICA Expo, Washington, PA
- As NIA President, brought more attention to irradiated glass with education, and encouraging the development of an NIA Fake and Altered Display and the Research and Authentication Chair position.

DEALER CONTRIBUTIONS: (Number of years, shows attended- especially long distances from home, etc.)

Attended or set up at various shows from NIA Nationals, NIA Regionals and Local shows from the early 1970's to present. Estimated that Rick has set up, or attended over 100 shows, not including all of the Bottle and collectible shows, in addition to Insulator Shows.

MISCELANIOUS COMMENTS:

Rick and Berny Baldwin have been involved in the insulator hobby and instrumental to the support and success of the Western Reserve Insulator Club since shortly after its founding.

Rick is also a past NIA President, serving 1 term then subsequent "1st Past" and "2nd" past terms, as well as serving at the Central VP prior to that, and also as the NIA Show Standards Committee Chairman. In all, Rick served the NIA, either as a Committee Chair or as a Board Member for a total of 14 consecutive years. Rick is a Charter Member of the NIA and has been active in the insulator collecting hobby since 1972. This marks his 50th Anniversary in the NIA.

Rick has been the Western Reserve Insulator Club Vice President from 2016 to present, and as such, he and Berny have put in countless hours in the Club's Show preparation, as well as promotion of the hobby by posting of our shows in social media, writing show reports for Drip Points as well as articles for the club newsletter, and encouraging new collectors to attend shows as well as mentoring new club members.

Rick and Berny are also members of the FOHBC and the Ohio Bottle Club, where Berny served as treasurer to the OBC from 2006 to 2016.

Rick and Berny Baldwin represent the best of what our hobby encompasses: the camaraderie of the people as well as encouraging new collectors in learning more about insulators, and the hobby in general. As "Dr. Rick" has said "[new younger collectors] are the individuals who represent the future of our hobby and our organization, as they are the sources of new ideas, energy and enthusiasm!..." Learn, share, educate, get involved and help perpetuate the wonderful and positive aspects of our great hobby."





NIA PRESIDENT

DARRYL WAGNER * NIA #8671

NIA HALL OF FAME AWARD

Nominee: Bill Meier
Date of Birth: November 22, 1955
NIA#: 4322 – 34 Year Member

Bill Meier has been involved with the insulator collecting hobby for decades. He was one of the pioneers in bringing technology to be a useful tool for collectors. For over 25 years, he has managed and grown the insulator collectors mailing list, now known as ICON (Insulator Collectors on the Net). He created the first significant world wide web presence for the insulator collecting hobby in insulators.com, now insulators.info. Over the years features have been added to the website that have great significance to the hobby and have contributed to its growth. insulators.info is the home base for ICON. The picture poster, Insulator Gazette and the Patent pages are some examples of the tools provided to the hobby by Bill.



In regards to the NIA, Bill has been a member since 1988. Bill & Jill have provided many displays at National shows and helped raise the standards for insulator show displays that have carried through to today. He received multiple awards at different Nationals for some most of his displays. Bill served as the Eastern Region Vice President 1995 – 1998 and Awards & Recognition Chairperson 2003 – 2005. Bill has assisted many show hosts, multiple times with name tags, directory assistance and display judging. He is a regular dealer at most Nationals and Springfield shows. He was a co-host for the 1995 & 2010 NIA National shows. He is currently a member of the NIA Directory and Technology committees.

Some NIA Awards:

- NIA President's Award 2011 & 2021
- NIA Outstanding Service Award 1998, 2007 & 2021 (Only member to receive 3)
- NIA Lifetime Membership in 2002

Bill has been involved with the Yankee Pole Cat Insulator Club for many years and Bill and his wife Jill have the Bill & Jill's Insulator Auction and he assists with several other insulator and hobby auctions. He also assists with the Price Guide Browser.

Collectors can come and go, some assist with the NIA and or the hobby for a while, then slow down participation, but Bill has consistently been incredibly involved with the NIA and the Insulator Collecting Hobby. He has donated a massive amount of his personal time and life for the hobby and is an outstanding steward of the insulator collecting hobby.



A new way that collectors can have money donated to the NIA is by utilizing Amazon Smile. The NIA is now a registered charitable organization with Amazon. A lot of us use Amazon on a very regular basis. Now you can choose to donate 0.5% of your purchases to the National Insulator Association, Inc. Use this link to choose this option:

<https://smile.amazon.com/ch/86-0991996> This should

guide you through the process. You should use the new address to shop. Feel free to reach out to me if you have any questions, need help with signing up or have any problems. Thanks Darryl





DRIP POINTS AWARDS

Drip Points has become a magazine that members look forward to receiving and that is because of our editorial staff and the articles and show reports submitted for publication. In recognition of that, we now have the Drip Points Article category awards. There will be 4 categories, North American Glass, North American Porcelain, Worldwide and General. This year we awarded three of these categories and you can see the winners below. The Board voted on the winners this year, but next year, you the membership, will have the ability to nominate and vote on articles in each category. In the December issue this year, you will be asked to nominate articles published in 2022 for each category. Your nominations will need to be received by the Awards Chairman by March 1st. The April issue of Drip Points will then ask for votes on each category and that they be submitted to the Awards Chairman by May 31st. Articles can only win one category. An author can not win the same category two years in a row. The Board of Directors has discretion to use a variance as needed.

This Year's Winners:

**North American Glass, The Montana Stacker, April 2021 Issue
Doug Rusher**

**Worldwide Insulators, The Not So Boring Cordeaux, Jun/Aug 2021 Issues
Jack Nesbit**

**General, Hemingray Odds & Dead Ends, Aug/Oct/Dec 2021 Issues
Christian Willis**



PRESIDENT'S AWARDS

The President's Awards are given each year at the discretion of the NIA President, to show appreciation for service to the NIA or the hobby. The President's Awards were given this year to:

Dwayne Anthony for his continued efforts with the NIA altered display.

Mike Green for his Collector's Spotlight articles for 2021.

Jack Nesbit for his continuous submission of articles for Drip Points.

Nathan Holmes for their assistance with Drip Points as an assistant editor.

Christian Willis for his time as the NIA Information Director & Editor of Drip Points.

Andrew Gibson for his efforts as the NIA Membership Director.

Bill Rohde for his ongoing service at the NIA Treasurer and his many other contributions.



ANDREW GIBSON RECEIVING HIS AWARD





NIA PRESIDENT

DARRYL WAGNER * NIA #8671

NIA 50 YEAR MEMBER PHOTOS AND RECOGNITION

The NIA reached a milestone this year in that we now have a few members that have reached 50 years of membership. This year we awarded eight NIA members with a 50 Year Recognition Award. They were:

- | | |
|------------------|----------|
| Elton Gish | NIA #41 |
| Sherry Lu Krell | NIA #252 |
| Doug MacGillvary | NIA #259 |
| Richard Baldwin | NIA #336 |
| John De Sousa | NIA #419 |
| Darrell Karlin | NIA #440 |
| Joseph Beres | NIA #563 |
| Dick Bowman | NIA #597 |



ELTON GISH & RICHARD BALDWIN RECEIVING THEIR AWARDS



NIA HISTORIAN

RICK SOLLER * NIA #2958

Collectors of Australian porcelain will be delighted by the new book by Martin Brabon titled *Sunshine Porcelain Potteries – A Short History* which was copyrighted in 2021, not published until 2022, and recently added to the NIA archives (as well as my personal collection of books). Although the title suggests the book is brief in nature, nothing seems further from the truth. The 246 pages of the 8-1/2” x 11” book are jammed with extensive research and pictures on all aspects of the pottery. The footnotes alone take up 24 pages!

Brabon is ideally situated to write this book. He grew up living next to the Drayton family, who started the pottery, and spent much time with them. They also provided assistance and material to write the book. In addition, the factory was located a short distance from his childhood home.

Not every page is devoted to insulators. The book serves four audiences: A general audience, insulator collectors, jug collectors, and the people of the Melbourne suburb of Sunshine where the factory was located. Nevertheless, tidbits about insulators are sprinkled throughout the book.

Early chapters in the book provide a brief history behind the need for insulators as well as a description of the ups and downs of the pottery. Issues involving WWII as well as fires at the pottery, for example, are covered. Multiple aspects of the pottery are covered with a chapter on family members involved with the pottery and a chapter on production processes. This later chapter is especially relevant to anyone collecting porcelain insulators since it covers the raw materials used, how they were mixed, the firing process, and the testing process. Photographs of these processes cover several pages. Politics of running a business are also covered with discussion of tariffs, unionism, hiring of employees with criminal records, treatment of veterans, immigration, and charitable activities.

The 23 pages of chapter 7 are where insulators are covered in detail. Sunshine made a variety of insulators including fuse holders, cleats, massive radio tower bases, suspensions, shackles, strains, spools, bus bar, pedestal, fence, auger screw, rack, multipart, and, of course, pintype insulators. Catalog and color pictures of these are shown throughout the chapter. Noted collectors Teresa Dempsey and Noel Dawson provided some of the photographs for this chapter.

For those interested in their own copy of the book, the author can be reached at SunshinePottery3020@gmail.com. Copies can be purchased for AU\$46.50 (US\$31.79) plus postage. I would highly recommend the book.

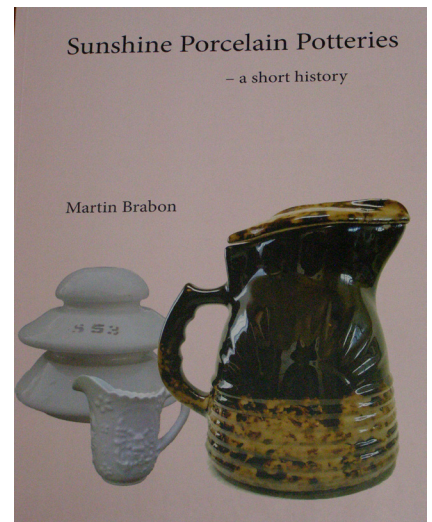



MARGARET WAGNER * NIA #8711



DIRECT SUNLIGHT



UNDER U.V. LIGHT



TOP EMBOSSEING

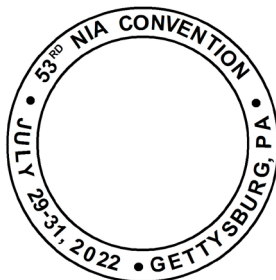

BASE EMBOSSEING

Introducing the "Gettysburg Ghost"

This year's NIA Commemorative, the "Gettysburg Ghost", is made from uranium glass and glows brightly under a blacklight. There have been a couple of other commemoratives in the past that had uranium glass in them, but this is the first from a custard yellow. It will make a unique addition to your collection or for display.

As always, everything is dependent upon availability.

Regular pour - \$45.00 each/ppd
Solid pour - \$55.00 each/ppd

Note: Solid pours are not plunged. They vary in size and can be crude. They may lean or have flaws and they have no base markings.

Refer to the NIA website for other previous year's commemoratives that are available. Prices vary, depending upon year, but there is some special pricing available for certain years.

Thank you for your support of the NIA and the NIA Commemorative program.

History of the National Show Commemoratives: "Collecting Our History"

Being an enthusiastic insulator collector, Frank Miller of Tulsa, Oklahoma went home from the First National Insulator Meet (that's what the "National" show was referred to as in 1970) held in New Castle, Indiana with an idea that collectors should have something by which they could remember the National meets. After months of struggling, he managed to have an insulator mold made. Frank said it was often referred to as "Frank's Last Folly" since he retired from teaching shortly thereafter. He also said it was worth the struggle. The commemorative insulator he designed replicated the early threadless "Pilgrim Hat" (CD 736) and is almost 4 inches high and is 3¼ inches across at the base. Since 1970, the glass commemorative has marked the National show event with new embossing for the location and a new color of glass. In 1979, the project continued on by John & Carol McDougald of Sedona, AZ. John and Carol produced the yearly commemoratives through 2009, at which time they donated the production to the National Insulator Association starting with the 2010 commemorative. Any profits made from the NIA Commemoratives go directly to benefit the National Insulator Association, a 501(c)(3).

To place your order online, please visit:
<https://www.nia.org/products/commemorative/>
We accept PayPal.

Alternately, you can send your order and payment to:
Margaret Wagner
14615 Skyview Ave.
Smithville, MO 64089
(816) 719-0801
commemorative@nia.org

Please make checks payable to "NIA".
If you have additional questions or live outside the continental United States, please contact me by phone or email prior to your order. Thanks!

DRIP POINTS MANAGING EDITOR

DOUG RUSHER * NIA #1773

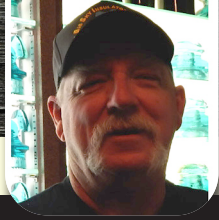

I hope everyone is having a great summer as fall is just around the corner and soon winter will be upon us, I truly hope things get back to normal, I'm hoping Covid is in the rearview mirror and we can get back to cheaper gas, motels and groceries as this all cuts into our insulator money and getting to the shows that we all really enjoy and seeing our good friends from the hobby that we all so much love. That being said, for those of us that couldn't make it to all the shows we wanted to, we have tried to bring the shows to you in this issue, there are lots of show reports, especially the Gettysburg National and the NIA now has a Youtube channel so you can see the great presentations done by Dario on threadless, Jeff Katchko's Harloe dig and the discovery of the NEW CD 206.7 Harloe Power Claw as well as the awards banquet. This is just the beginning of our new You Tube Channel and thanks to our new promotions Chairman Spencer Garten for working so hard on recording the outstanding presentations (you can read more about it on page 18 under Spencer's Report) I would encourage any of you if you have a presentation you would like to share with the hobby, please contact Bob Berry or Spencer about it. I would also like to congratulate everyone for their displays at the National. For you folks who have never done a display at a National or show it's not a easy task, countless hours go into getting everything ready and then packing up everything then setting it up and then before you know it time to pack it up and get it home safe and sound, But it is really rewarding and that's why I keep doing it, however every year the boxes keep getting heavier and heavier and I keep getting older, but that just goes along with it, so if you have never done a display I highly recommend you consider it. You won't be sorry. Getting back to awards I would like to congratulate my fellow recipients of the Drip Points Award Christian Willis and Jack Nesbit and I would like to remind everyone that you don't have to be a professional writer to receive one of these awards you just have to sit down and write a good article that will benefit the hobby, whether its on your favorite CD, the history of a line, the type of insulator you collect, go withs etc. We could really use some good mud articles so give it a shot you will be in the running for the Drip Points Award for next year and the winners will be announced at the Logan National and the winners will receive a beautiful plaque for that category. Last but not least, please consider going to the Logan Utah National Next year as Don and Jeannie are working so hard to make it a national everyone will be talking about for years, so get your tables reserved early and think about doing a display - you will see mine there. HAPPY COLLECTING ▲

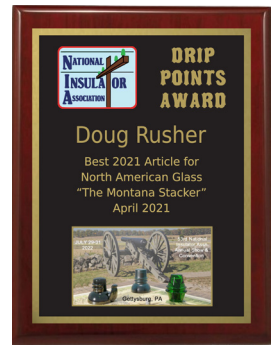

WESTERN REGION VP

ROGER ZIESAK * NIA #8919

Highs and Lows

Our hobby always has something new going on. Maybe not brand new, but every show I've been to this year has been great because of the variety of glass and mud as well as new faces. Seeing something super rare is always fascinating to me as it gets me wondering about the history of the piece. How it was used, where it was used. Was it a successful design? Great questions leading to great discussion and/or research. The National had several pieces like that with great presentations and for me, personally, it was the purchase of early porcelain that I had a better chance of finding on the east coast rather than Montana. I was able to get several early, small, mud power pieces including a U-989. I didn't even know I wanted it until I saw it. Great crude early piece from the Southern Porcelain Company. I learned a lot about it from several folks there. A real high point.

We are a close-knit hobby as well with many strong friendships and people who leave us with a lasting impression. We, our hobby and personally, have lost several collectors over the last few months and that is a loss we all feel. Two great friends of mine, Carol Blakely and Gil Hedges-Blanquez passed away this summer and I was deeply saddened each time. They had become true friends through the hobby and I will miss them. Enjoy the friendships this hobby brings us and reach out to folks to just make contact occasionally. It's always rewarding to talk insulators and to just be in touch. ▲

All the Best,
Roger

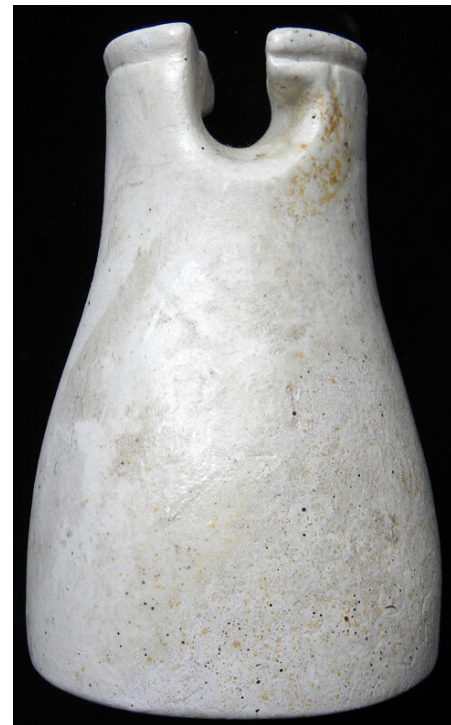

THE CONFEDERATE U-989 MILK BOTTLE

NIA SCHOLARSHIP COMMITTEE



TAMMY BREWER * NIA #6696

This year the scholarship committee recommended three applicants to the NIA board, and we are pleased to announce that all three were approved for \$1000 academic scholarships for the 2022-2023 school year. The scholarship committee was in unanimous agreement that all three girls were equally deserving of the NIA scholarship because of their involvement in the hobby.

Mary Kay and Shelby Jo Wanechek, daughters of Larrin and Helen Wanechek, will be attending the University of Idaho. Mary Kay plans to major in English, and Shelby Jo will be majoring in Business and Economics. Valkyrie Gibson, daughter of Andrew and Samantha Gibson, is a sophomore at Boston University majoring in Chemistry. Kyrie has grown up attending shows in New York, Ohio, and PA while Shelby Jo and Mary Kay spent their time visiting West Coast shows.

We would like to thank the board and all of you who donated to the scholarship fund this year. Because donations were up this year, we were able to award three scholarships instead of two. Please consider donating to the scholarship fund so that we can continue to help more young collectors without placing a burden on the NIA general fund. ▲

EASTERN REGION VP



GUS STAFFORD * NIA #8871

First off, thank you to everyone who helped with this year's National in Gettysburg, PA. It was wonderful to host so many collectors from around the country. There's another article in this month's Drip Points that covers the National in detail, so I'd like to focus on something that happened behind the scenes. By now, everyone knows about the coming out party for the CD 206.7 "Power Claw" in Jeff Katchko's awesome Harloe Insulator Company Dig display. (See page 33 for details.) I thought you might like to see how the Power Claw came together – literally!





EASTERN REGION VP

GUS STAFFORD * NIA #8871



Jeff's decades of digging in Hawley, PA yielded five pieces that we were able to assemble into the unique insulator that stole the show in Gettysburg. The first portion of the repair was creating the missing half of the threads, and corresponding inner skirt. We made a latex mandrel using another Hawley insulator and molded the threads using Sculpey Modeling Clay.



We hardened the clay using a 100 watt lightbulb in a cardboard box.

With the insides in place, we added the two skirt pieces, making sure that we had solid concentric circles of the correct diameter.



With a solid base, we were now able to model the remainder of the external portion of the insulator. We carefully recreated the missing embossing using a CD 145 Harloe for scale.

Jeff was fortunate to find both side claws, but we were missing the front of the large "knuckle" in the middle. To assist in the reconstruction, we used a shard of a CD 206.5 as our model.

The final step in the preparation was smoothing out our repair and rounding the embossing to match the script on the original insulator. We molded the insulator and replaced the clay with color matched resin.



Being involved in the reconstruction of this historic Insulator was truly one of the highlights for me at this year's National. What will we find in the coming year? Who knows, but, I for one will be out there looking! 🍷

DIRECTORY COMMITTEE CHAIR

NATHAN HOLMES * NIA #4002



If you haven't pre-ordered your 2023 printed Insulator Collectors Directory - either when you paid your 2022 NIA dues or separately - there's still time! We'll be holding orders open until October 7, when we have to give the printer the final number. This high quality, spiral bound color reference to collectors worldwide is immensely handy for reaching out to other collectors. I use mine all the time, and keep one in my desk and one in the car. If you want to order yours, don't delay! NIA members receive a special discounted price of \$10 postage paid for pre-ordered directories. Visit insulatorcollectors.org/purchase to order yours before time runs out!

Now that I got that out of the way, let's give you an update on where we are with the directory. The 2023 printed directory should be going to press a few days after you read this. It includes any 2022 NIA member who chose to be listed, as well as any collector who joined through the insulatorcollectors.org website and likewise indicated they wanted to be in the printed book. Bill Meier, Andrew Gibson, and I have been diligently working to pull it together since August, along with help from Darryl Wagner. The new 2023 book should drop in the mail around the last week of October and be arriving in mailboxes in November. They do travel on the lowest cost postage, so it may take several weeks to reach you. It's a big job and those guys do a lot of the heavy lifting to get it done.

This will be our third printed directory as the NIA Directory Committee. You might be thinking "I bought one last year, do I really need another one?" YES! This year's directory will have dozens of new collectors added to it, as well as hundreds of other small listing changes as people update their contact information.

In an effort to keep the listings current and accurate, we've started sending out emails to folks who haven't updated their information in a while. When we create the printed directory every September, we'll age out anybody who either hasn't been an NIA member or has not gone into the website and verified that their information is still accurate for two years. It's an important step in making sure our information doesn't get stale!



THE CURRENT DIRECTORY
COVER - THE NEW 2023
DIRECTORY WILL AVAILABLE
IN NOVEMBER

Manage your Insulator Collectors Directory profile

Basic information:
 First name: Nathan
 Last name: Holmes
 Nickname: []
 Email: nholmes@digirenet.com
 Updated: September 9, 2022
 NIA member status: Yes, member #4002

Contact information:
All fields are optional, except Zip/Postal code which is used for demographic purposes only. However, the majority of our members include their address. This will help other collectors connect with you.
 Address: 5570 Farnes Cr
 Address 2: []
 City: Colorado Springs
 State: CO
 Zip/Postal: 80915
 Country: USA
 Phone: 719-235-1288

Directory selection:
Please indicate the directories you personally want to be listed in. The online directory gives you the option ???
 Online: Public Only Members No
 Printed: Yes No

Indicate which fields you want included in the directories you selected:
 Online: []

TAKE ADVANTAGE OF THE
ONLINE DIRECTORY AT
INSULATORCOLLECTORS.ORG

Did you know there's more to the directory than the printed edition? There's also the online edition of the Insulator Collectors directory at insulatorcollectors.org. If you're an NIA member, just log in with the email address on file with the NIA and we will automatically pull in your information. You can then update it for the directory, or change what information you choose to share (name, address, email, and telephone) both in the online directory and in next year's printed directory.

Since dues season is once again upon us, I want to remind you that as NIA members, you can choose to be included in the Insulator Collectors Directory when you renew every year. It's important that you check the "YES" boxes on your renewal form to the questions about the Hobby Directory if you want to be included (not only that you want to be included, but which information you want included). If you don't give us a "YES", we have to assume that you *do not* want to be included for privacy reasons. That "YES" will go into effect next fall when we merge all the 2023 NIA member who chose to be listed into the Insulator Collectors Directory database. For the lifetime members out there who don't submit a dues form every year, you can either log in to the website and set your preferences there, or communicate them to Andrew Gibson (membership@nia.org) to update the master NIA database.

State/Province	1
Zip/Postal Code	2
Country (if not U.S.)	3
Telephone Number	4
E-Mail Address	5
<small>(An e-mail address is required for the electronic version of Drip Points)</small>	
Include me in NIA Hobby Directory: On-Line	Yes <input type="checkbox"/> No <input type="checkbox"/> Printed Yes <input type="checkbox"/> No <input type="checkbox"/>
Include my USPS Address in:	On-Line Yes <input type="checkbox"/> No <input type="checkbox"/> Printed Yes <input type="checkbox"/> No <input type="checkbox"/>
Include my Email Address in:	On-Line Yes <input type="checkbox"/> No <input type="checkbox"/> Printed Yes <input type="checkbox"/> No <input type="checkbox"/>
Include my Telephone Number in:	On-Line Yes <input type="checkbox"/> No <input type="checkbox"/> Printed Yes <input type="checkbox"/> No <input type="checkbox"/>
You may pre-purchase the next printed Hobby Directory for \$10.00 Yes <input type="checkbox"/> No <input type="checkbox"/>	
Signed _____	Date _____ To _____
NIA MEMBERSHIP BENEFITS	

REMEMBER TO CHECK "YES" ON YOUR RENEWAL!
WE NEED YOUR PERMISSION!

One more incentive to pre-order your directory now... prices are going up. Sorry, I hate to be the one to break the news, but our printing costs have gone up by double digit percentages. So the pre-orders for next year (2023 dues, 2024 printed directory) will be \$12 for NIA members.

I want to thank all of you that have supported the directory, both by being included in it and for purchasing the printed editions. It's an invaluable reference to me, and I hope to all of you as well, and I think it's vital for our hobby to be able to find other collectors. Thank you!

Nathan Holmes - directory@nia.org



MEMBERSHIP DIRECTOR

ANDREW GIBSON * NIA #2422

With Fall just around the corner, we can start to look forward to Springfield, and other local shows. It's also time to start thinking about membership renewals! I send out early email renewal reminders to folks starting in mid-September or so (which means that by the time you read this, you may already have gotten one!). Come October, I will send out hardcopy renewal reminders to anyone who hasn't yet renewed for next year.

Just to make sure people are aware, the NIA Membership Year runs from January 1 through December 31. The first edition of Drip Points is the February one, and I usually send the official distribution list to Doug sometime around the middle of January. If you renew after this point, you will not receive the February edition of Drip Points. Obviously, the later in the year that you renew, the more issues you may miss. I highly encourage everyone to renew prior to January 1 so as not to miss any of the great information contained in this magazine!

Come February, I'll send out late email reminders, and a few weeks after that I'll send out late hardcopy reminders. If you don't renew at that point, there won't be any more reminders from me, and you'll be missing out on one of the best ways to stay in touch with the hobby, keep up-to-date on new finds, read historical information, see what's going on at shows, and plenty more.

Renewing early also saves the NIA money, as we don't have to keep sending reminders. And it saves ME time as I don't have to stuff quite so many envelopes. I usually get Ian and Kyrie to help with that task, but with Kyrie off to college and Ian a senior in high school, they don't have as much time to help out anymore.

So, please, do us all a favor and renew early! 🐿



NIA PROMOTIONS

SPENCER GARTEN * NIA #10044

This is my first report as the new Information Director and chairman of the Promotions Committee. I hope we can get a few things accomplished over the next year.

First, the NIA has created a public YouTube channel. YouTube is a website where videos can be uploaded for anyone to view. You do NOT need a YouTube account to view the videos and you do NOT need a social media account to view the videos. Simply go to www.youtube.com and type "National Insulator Association" into the search bar to find the NIA's channel. Currently, three videos are available from the 2022 National at Gettysburg. YouTube is not like Facebook. NIA members can submit videos for review, to be uploaded to its channel. If you have a historical, technical, educational, etc., video you believe would benefit the channel, please contact Bob Berry, the NIA's webmaster and technology committee chairman.



Also outside of Facebook and other social media, the NIA has its own online forum created and run by David Baron NIA #9028. It is called the "NIA Companion." There, you can participate in discussions about insulators or buy and sell them. There is also a built-in tool for cataloging your insulators. The forum can be found here: <https://companion.nia.org>.

Third, we have been working on a "traveling display". This will be a cabinet for both glass & porcelain insulators, with additional security features to prevent theft. With this display, the public will see insulators in a "new light." Hopefully, this will spark their interest and make them aware of our collecting community. After it has spent some time in one location, members of the promotions committee will move it to another. We will begin with one display in the eastern region and if it is well received, one will be made for each region. This project has a large upfront cost. Please reach out if you'd like to donate insulators to be used to raise money for the displays, to be used in the displays themselves or to donate money towards their construction and transportation.

As with all associations, new members and retention are what keeps them going. We will be adding a line to membership applications asking them how they heard about the NIA. Data from this line will help the NIA direct its recruiting efforts. If you find the time, please email me regarding how YOU found the NIA and what it is that makes you sign-up each year. We don't want to take away anything that our members enjoy.

Have ideas for promoting the NIA? Want to help? Please contact me at: promotions@nia.org 🐿

WANTED

TO BUY:

SINGLES OR COLLECTIONS GLASS AND PORCELAIN



Also wanting any Power company signs,
linemens tools, Birdhouse fuse boxes, Early Line construction tools, shotgun sticks, scab sticks, early transformers, any items you think I might be interested in
PLEASE CONTACT ME



WE SELL
"KLEIN"
LINEMENS TOOLS

Jason Townsend

jtins@gmail.com - Cell (630) 667-3357

720 N. Dekalb Street
Sandwich, IL 60548

54th Annual NIA National Show

Logan, Utah • June 9-11, 2023



Join Us for the First Ever National in Beautiful Utah!

Cache County Fairgrounds Event Center

450 South 500 West • Logan, UT 84321

Show Times:

- Friday, June 9th (NIA Members Only) 9:00 am – 4:00 pm
- Saturday, June 10th (open to public) 9:00 am – 4:00 pm
- Sunday, June 11th (open to public) 9:00 am – 1:00 pm

For more information, visit:

http://www.nia.org/shows/2023_national/

Proudly Presented by Your Show Hosts:

Don & Jeanne Briel

(435) 753-5786

Don.Briel@comcast.net

Brian & Cathy Weese

(801) 201-5187

brianlweese@gmail.com



Pre Show Activities:

Thursday, June 8th, 2023
Bus trip to Golden Spike National Monument, Northrup Grumman (Thiokol) Rocket Garden.

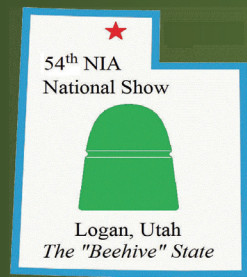

Our Host Hotel's are the Marriott SpringHill Suites and the Townplace Suites

Enjoy the Local Area:

- American West Heritage Center (a working farm that depicts life in the early West):

<http://awhc.org>

- Numerous antique shops
- Dozens of restaurants
- Stokes Nature Center in Logan Canyon:

<http://logannature.org/>

- Wind Caves and other hiking in Logan Canyon:

<http://logancanyonhiking.com/>

- Public pool and waterslide across the street from the fairgrounds
- Park and small zoo on the south side of the fairgrounds
- Numerous fishing streams and reservoirs
- Cache Valley is about halfway between 5 national parks to the south with Teton and Yellowstone National Parks to the north.

For a long list of other attractions, visit:

http://www.nia.org/shows/2023_national/

GETTYSBURG

THE 53RD NATIONAL INSULATOR ASSOCIATION SHOW & CONVENTION

SHOW REPORT BY GUS STAFFORD & MARY ANN PIKE
PHOTOS BY NATHAN HOLMES, DARIO DIMARE & BILL MEIER

Over the weekend of July 28-30, 2022, show hosts Gus Stafford, Justin and Emily Stoudt, Mary Ann Pike, and Steve Gosciminski as well as the rest of the Chesapeake Bay Insulator Club were happy to welcome hundreds of collectors to the 53rd National Insulator Association Show & Convention at the Wyndam Hotel in beautiful and historic Gettysburg, PA.

On Wednesday, early arrivers were treated to a tour of Gettysburg Civil War sites, and everyone praised the tour guide for the way he explained the historical context and made the attendees feel like they were actually observing the action he described. Thursday's early arrivers toured the Pennsylvania state capital building in Harrisburg, PA, known to be one of most beautiful capitol buildings in the country. In addition, the group took a short paddleboat ride on the Susquehanna River, and concluded the day with the Hershey's Chocolate World tour that explains the chocolate production process (and of course got to shop for Hershey products afterwards, some of which are only available at Chocolate World). Thanks to Tammy Brewer for organizing these enjoyable extracurricular activities.

The show hall was filled with tables of insulators and go-withs for sale in all price ranges. Several unique insulators were brought for show and tell by their owners. The walk-in crowd was good, with people waiting outside of the hall to gain entry at the start of each day. Many of the people roaming the hall were non-collectors or new collectors who had never attended a show before. We had over 350 paid attendees at this year's show, coming from 25 States as well as Canada. The NIA meeting on Friday afternoon and the banquet on Saturday were also very well attended.



THE SHOW VENUE - THE GETTYSBURG WYNDHAM



COLLECTORS TOUR THE PENNSYLVANIA STATE CAPITOL IN HARRISBURG ON THURSDAY BEFORE THE SHOW STARTED



LEARNING ABOUT THE ACTS OF VALOR AND SACRIFICE THAT SHAPED OUR COUNTRY ON THE GETTYSBURG BATTLEFIELD

THE 53RD NATIONAL INSULATOR ASSOCIATION SHOW & CONVENTION



SHOW REPORT (CONTINUED)



Although not as elaborate as some at past shows, the displays were educational and eye-catching. Two of the exhibitors gave talks about their displays. On Friday, Jeff Katchko gave an engaging talk to an enthralled audience describing his 20+ years of excavation at the site of the old Harloe glass factory in Hawley PA. His display contained many insulators and other artifacts that he unearthed from the site, including a previously unknown (huge!) style of Harloe claw. On Saturday, Dario Dimare gave an introduction to the history and production of threadless insulators. Dario brought many fine specimens from his collection to illustrate his topic. Dario and Jeff's talks were recorded and are available online.

Our club's non-competitive Blue vs Gray insulator display was a big hit with the attendees. Two tables covered with artificial grass were filled with blue and gray insulators of all shapes and sizes, with a host of Civil War figures scattered among them. We got a lot of compliments on the display. Thanks to Ken Willick and Matt Grayson for contributing their blue and gray porcelain that, along with pieces from my (Mary Ann Pike's) collection, filled the tables with warring insulators!

With over 100 sales tables and 12 Outstanding displays, the show hosts made sure that every participant received an NIA / CBIC Commemorative Coin in a walnut Keystone Base and a CD 162.5 P.R.R. to remember the event. Our daily raffles helped make the show a financial success with notable items including Civil War Soldier insulators, an insulator chess set, a Pennsylvania Railroad Lantern, an original Bill Haley painting, and many groupings of insulators and commemoratives.

Sunday was rather hot and muggy as everyone started to pack up, but all seemed to have done well with sales and enjoyed the company of their fellow collectors. Thank you to everyone who volunteered in any way and helped to make the show a success.

The Chesapeake Bay Insulator Club last hosted a National Show in Williamsburg, Virginia in 1998. The show hosts were Mark Becher and Marcia Wells from MD, Gus Stafford and Mike Doyle from VA, and Jim Frustieri from NJ. Neither Mike, nor Gus were able to attend the show. Mike shipped out with the Navy, while the Army moved Gus and his family prior to the show. It was fitting that the 1998 Show Hosts (minus Jim) were able to do a mini reunion at this year's National!

The one sad note in all of this was the loss of Jeff Hollis, who died unexpectedly the Sunday prior to the show. Jeff was our longtime secretary, treasurer, and membership chair, and the organizer of the yearly CBIC show in Martinsburg WV. At our CBIC shows, Jeff's smiling face was the first thing you saw when you walked through the door. In addition to the CBIC, Jeff was very involved with many community organizations including his church, Boy Scouts, and the Berkeley County Roundhouse Authority Board of Directors, and he shared a love of geocaching with several other insulator collectors. His death was a terrible shock to everyone, and he will be greatly missed by all who knew him. 🙏



THE DEALER AND DISPLAY AWARDS - CD 162.5S AND U-179S



THE 53RD NATIONAL INSULATOR ASSOCIATION SHOW & CONVENTION

SHOW REPORT (CONTINUED)



GUS MANS THE FRONT TABLE ON SATURDAY AS PEOPLE LINE UP TO GET IN TO THE SHOW



RALPH DEAN CHECKS OUT THE GLASS ON CHIP MCELWEE'S TABLE



ROD AND SANDY KRUPKA WITH THEIR USUAL ASSORTMENT OF LIGHTNING ROD BALLS AND A FEW INSULATORS



STEVE ROBERTS HANGS OUT WITH LOU HALL AND MIKE DOYLE AT THEIR TABLE



BOB BERRY LOOKS AT A PIECE ON FRED COLLIER'S TABLE



THE STOUTDTS' INSULATOR STORE TABLE HAD A NICE SELECTION OF COLOR, INCLUDING THAT RAINBOW OF DOMINION 42S



HANK HALLAM'S TABLE AND OTHERS IN THE BACK CORNER OF THE HALL



COLIN AND MAY JUNG TRYING TO CONVINCE BILL HALEY HE REALLY WANTS TO TAKE THAT PURPLE CAL 260 HELMET HOME WITH HIM



A REUNION OF THE 1998 WILLIAMSBURG NATIONAL HOSTS: GUS STAFFORD (HOLDING A 2022 COMMEMORATIVE), MIKE DOYLE, MARCIA WILLIS (HOLDING A 1998 COMMEMORATIVE), AND MARK BECHER. THE FIFTH HOST, JIM FRUSTIERI, COULDN'T MAKE IT THIS YEAR.

THE 53RD NATIONAL INSULATOR ASSOCIATION SHOW & CONVENTION



SHOW REPORT (CONTINUED)



JOHN RAJPOLT WITH ALL SORTS OF EXOTIC GLASS, INCLUDING A COBALT CAL ELECTRIC WORKS CD 130 AND A LOCKE 266.5



TOD AND MARY ANN PIKE POSE WITH TWO VERY RARE PIECES - THEIR WESTINGHOUSE CD 116 AND A CD 1025 MINE SPOOL



DENNIS LOOKS ON AS JEANNE WEBER RELAXES ON THE GIANT THRONE IN THE LOBBY AFTER THE BANQUET



RALPH DEAN TALKS TO ANOTHER COLLECTOR ABOUT A GREEN PONY ON HIS TABLE



JUSTIN AND EMILY STOUDT MIND THE INSULATOR STORE'S TABLE



MIKE DOYLE AND BILL ROSARIO CHAT AS SHORTLY BEFORE LOU AND MIKE HEAD BACK FOR CALIFORNIA



THE SHOW'S STANCHIONS WERE ALL MADE BY STEVE GOSCIMINSKI. EACH WAS MADE OUT OF A TREE LIMB WITH A PIN AND A CD 162.5 OR U-179 PRR-STYLE INSULATOR ON TOP



DUDLEY ELLIS WOULD LIKE TO SELL YOU A FEW PIECES AT BARGAIN PRICES!



ANDREW GIBSON INSPECTS A PEACOCK BLUE NATCO 151 OVER COLIN JUNG'S LIGHT TABLE



THE 53RD NATIONAL INSULATOR ASSOCIATION SHOW & CONVENTION

SHOW REPORT (CONTINUED)



ALAN AND CELESTE COLBURN
HAPPY BIRTHDAY TO CELESTE ON SATURDAY!



DARRYL WAGNER SELLS A YOUNG
COLLECTOR A NEW INSULATOR



JOHN GASKO RELAXES AT HIS TABLE



KEN RICHARDS ADMIRES ONE OF THE EARLIEST
INSULATORS IN THE HOBBY - DARIO'S CD
780 "BUREAU KNOB"



CURT AND ALAN BOSTER POSE FOR A QUICK
SHOT WITH ALL THE GLASS THEY BROUGHT



GREG DRUCK IS CLEARLY HAVING A GOOD
SHOW SINCE HE'S SITTING BEHIND HIS SALES
TABLE SMILING AWAY



JOHN HOVANEC AT HIS TABLE



BILL ROSATO BROUGHT A BIG SELECTION OF
CANADIAN GLASS AND PORCELAIN



RICK AND BERNY BALDWIN OPEN UP A BOX
WHILE DARIO LEANS OVER. ANY THREADLESS
IN THERE? YOU MAY HAVE HEARD HE
COLLECTS THEM.

THE 53RD NATIONAL INSULATOR ASSOCIATION SHOW & CONVENTION



SHOW REPORT (CONTINUED)



TWO TABLES OF RAFFLE PRIZES GIVEN AWAY OVER SATURDAY AND SUNDAY. INCLUDED WERE NUMEROUS INSULATORS AND COMMEMORATIVES, TELEGRAPH KEYS, A TELEPHONE TEST SET, DATE NAILS, A SET OF GILDING WHEELS FROM A PENNSYLVANIA RAILROAD EMPLOYEE, A 3D-PRINTED INSULATOR CHESS SET BY BILL SNYDER, AND AN ORIGINAL BILL HALEY PAINTING OF A RAILROAD AND POLE LINE SCENE.



(ABOVE) A GOOD SELECTION OF COLORFUL FOREIGN GLASS ON NATHAN HOLMES' TABLE



THE SHOW HAD A BRISK CROWD MOVING THROUGH ON SATURDAY



BILL HALEY PRESENTS HIS PAINTING FROM THE RAFFLE TO WINNERS AL & BRENDA KLAUS



SEE PG57 FOR MORE INFO ON THE CD120

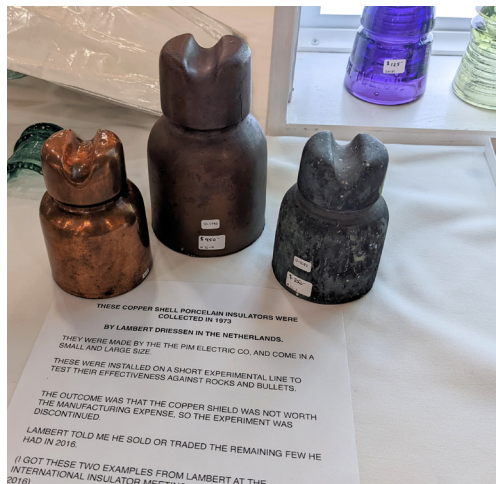

RARE BELGIAN COPPER-CLAD INSULATORS ON TOM AND LINDA KATONAK'S TABLE



BILL AND STEPHANIE SNYDER AT THEIR TABLE WITH BILL'S 3D-PRINTED RESIN "IMPOSTULATORS"



THE 53RD NATIONAL INSULATOR ASSOCIATION SHOW & CONVENTION

DISPLAYS & PRESENTATIONS



(ABOVE) DARIO DIMARE'S "21 B.C. - BEFORE CAUVET" DISPLAY OF EARLY THREADLESS INSULATORS
(BELOW LEFT) THE MAIN THREADLESS CABINET IN CD ORDER - (BELOW RIGHT) BLOCKS AND RAMSHORNS



THREADED AND THREADLESS COUNTERPARTS FROM THE SAME MOLDS. ALL ARE PERFECT MATCHES EXCEPT WHICH PLUNGER WAS USED TO FORM THE INTERIOR.



WAIVES AND CONFEDERATE EGGS IN VARIOUS STATES OF MELT FROM RICHMOND

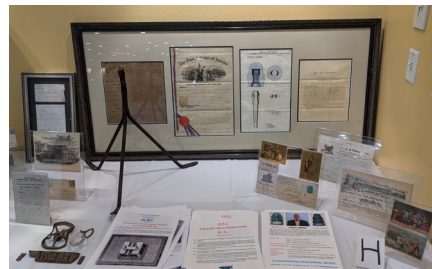

(ABOVE RIGHT) FLOYD'S 1867 PATENT FOR A THREADLESS INSULATOR WHERE A SPLIT METAL PIN WOULD SPRING OPEN TO SECURE THE INSULATOR, ALONG WITH ONE OF THE ORIGINAL MOUNTING BRACKETS



DARIO TELLS US ALL ABOUT HIS THREADLESS IN HIS SATURDAY PRESENTATION AND ANSWERS AUDIENCE QUESTIONS

Want to watch Dario's presentation about early threadless insulators? Check out the whole thing on the NIA's new Youtube channel by scanning this barcode with your smartphone, going to <https://tinyurl.com/dario21bc> or by searching for "National Insulator Association" on Youtube.



THE 53RD NATIONAL INSULATOR ASSOCIATION SHOW & CONVENTION



DISPLAYS & PRESENTATIONS (CONTINUED)



"THE BLUE & THE GREY" - A PORCELAIN CIVIL WAR-THEMED DISPLAY OF COLORFUL PORCELAIN FROM MARY ANN PIKE, KEN WILICK, AND MATT GRAYSON



MARY ANN PIKE'S DISPLAY OF PITTSBURGH HIGH VOLTAGE AND WESTINGHOUSE PORCELAIN



ALAN COLBURN'S DISPLAY OF SOUTHERN BELL TELEPHONE & TELEGRAPH (S.B.T.&T.) CD 112 KEGS AND GO-WITHS



THE 53RD NATIONAL INSULATOR ASSOCIATION SHOW & CONVENTION

DISPLAYS & PRESENTATIONS (CONTINUED)



JUSTIN STOUDT'S "JUST ANOTHER BORING LYNCHBURG" WITH LOTS OF COLORFUL, INTERESTING EXAMPLES PROVING THAT THEY'RE ANYTHING BUT BORING.



(LEFT & BELOW) - STEVE ROBERT'S DISPLAY OF VARIOUS MOLD STYLES AND COLORS OF EC&M CO. INSULATORS, AS WELL AS OTHER EC&M HARDWARE

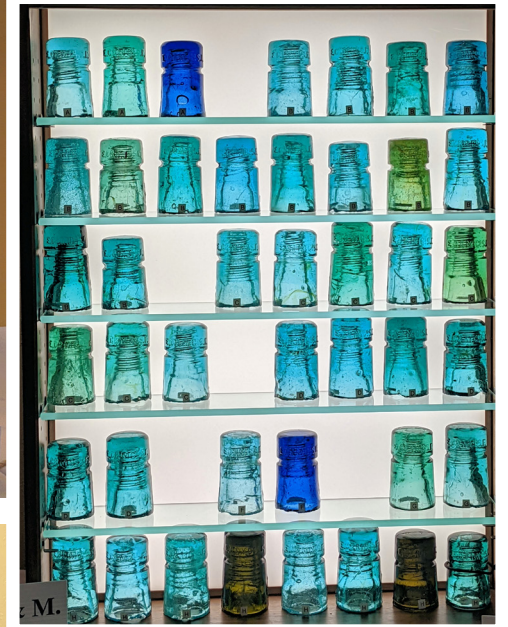

DON BRIEL'S EXHIBIT OF THE GALLOWAY INSULATOR ROOT, WITH A FEW INSULATORS RECENTLY REPLACED TO RESTORE THE ORIGINAL APPEARANCE

THE 53RD NATIONAL INSULATOR ASSOCIATION SHOW & CONVENTION



DISPLAYS & PRESENTATIONS (CONTINUED)

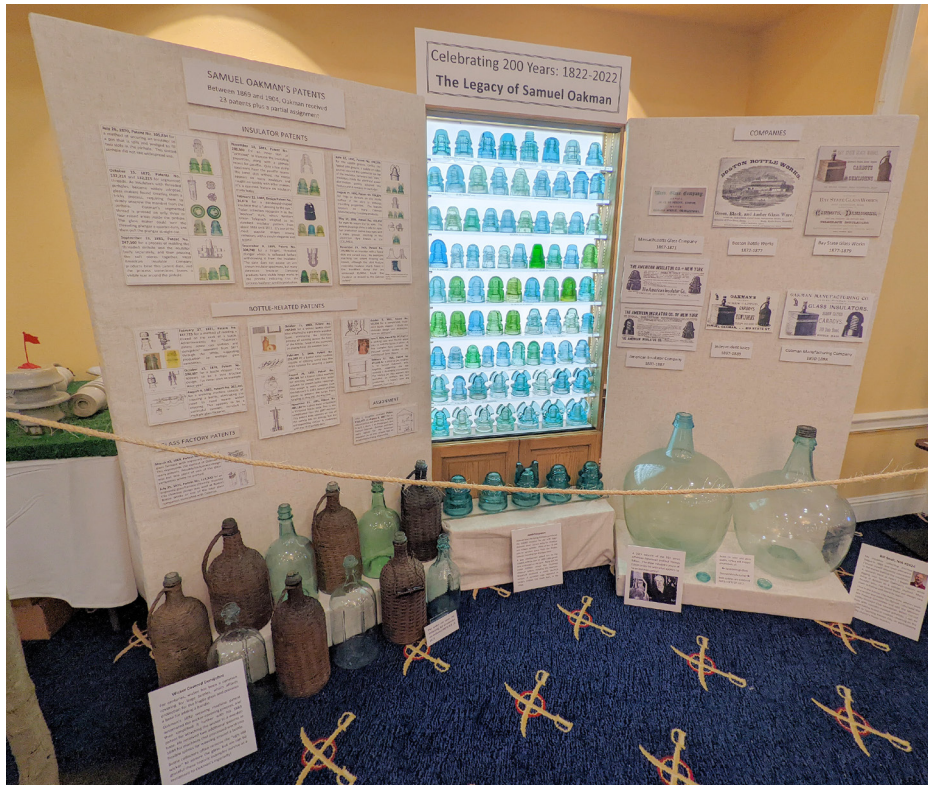

BILL SNELL'S "CELEBRATING 200 YEARS: 1822-2022 - THE LEGACY OF SAMUEL OAKMAN" FEATURED NOT JUST OAKMAN'S INSULATORS BUT ALSO HIS SCREW-CAPPED GLASS CARBOYS AND DEMIJOHNS



GIL HEDGES-BLANQUEZ'S DISPLAY OF RARE AND COLORFUL MEXICAN INSULATORS



BILL AND JILL MEIER'S "HEMINGRAY UNIVERSITY" USES A HUMOROUS AND LIGHT-HEARTED COLLEGIATE-THEME TO HIGHLIGHT SOME FANTASTIC AND RARE HEMINGRAY PIECES





RICK SOLLER'S DISPLAY OF INSULATOR MOLDS, INCLUDING MOLDS FROM THE ARMSTRONG 203 AND 230.2, THE KERR CD 155, AND THE TELEPHONE PIONEERS COMMEMORATIVE.



(ABOVE AND LEFT) JEFF KATCHKO'S DISPLAY ON THE PRODUCTS OF THE HARLOE INSULATOR COMPANY IN HAWLEY, PENNSYLVANIA, INCLUDING A LARGE NUMBER OF ARTIFACTS THAT HE PERSONALLY DUG ON THE OLD HAWLEY FACTORY PROPERTY. BE SURE TO READ ABOUT HIS PRESENTATION AND THE EXCITING DISCOVERY OF A NEW "CLAW" ON THE NEXT PAGE!

DISPLAYS & PRESENTATIONS (CONTINUED)

DISCOVERING THE CD 206.7

HARLOE'S No. 3.E. NO-TIE "POWER CLAW"

Perhaps the most famous products of the Harloe Insulator Company are the “claws” – a series of no-tie wire insulators based on Morton Harloe’s patent 715375, issued in 1902. Up until the Gettysburg National, two varieties of these insulators were known – the CD 109.5 “small claw” and CD 206.5 “large claw”. That all changed when Jeff Katchko made his presentation on Saturday, July 30.

Morton Harloe started with porcelain claw insulators. Those were successful, and he then decided to try the same in glass. Production of Harloe’s glass no-tie insulators started at the Sterling Glass Company of Elmer, New Jersey, in March of 1903, but moved to a new plant in Hawley, Pennsylvania, that fall.

Several decades ago, Jeff Katchko located the old Harloe glass factory in Hawley. The factory itself was a small site, only a couple acres. He located the owner and received permission to dig the property, eventually bringing Steve Bobb and Ken Willick along. The group eventually dug almost the entire property over the next 20 years.



JEFF KATCHKO HOLDING UP HIS 206.7

There are three types of small CD 109.5 Harloe claws known – the P1, the 12 P1, and the 14 P1, with the major difference is the thickness and shape of the claw fingers that secure the wire. The fingers get changed significantly between the variants, with Jeff proposing that since glass has less mechanical strength than porcelain, these are iterations on the prototype design to deal with breakage issues in the fingers. Jeff found mold numbers 1-6 on the site. The medium size CD 206.5 claws come in two variants – the P2 and the P2S. Jeff notes that no P2S pieces were found at the Hawley site, and proposes that the S may stand for “Sterling”. The P2S has larger claws and you can see straight through the wire slot, whereas all the other variants bind the wire between the claws. Again, there was signs of significant iteration in the dig, with mold numbers up to 8 found on the shards.



The new 206.7 is now the largest known Harloe no-tie insulator. The one existing example was rebuilt from five pieces of glass composing 60% of the insulator, mostly including the front claws and the embossing. Gus Stafford’s excellent resin reconstruction forms the rest. Unlike the other two which have a model number starting with P – which Jeff posits may stand for “prototype” – this one carries the model number No. 3.E. Jeff found pieces of no less than 20 different 3E claws in four mold numbers, but this was the only one intact enough to rebuild. The nickname – “Power Claw” – can be attributed Ken Willick during the dig, since the piece is much physically larger than the two previously known variants.

What an amazing discovery, and what an amazingly appropriate time to introduce it to the hobby! Despite Jeff having most of the pieces for some 35 years now, the repair and reconstruction of the piece was only completed two days before the show. A huge thank you to Jeff Katchko for his exhibit and presentation about his dig.

Want to watch Jeff's presentation about his dig at the Hawley glass factory and his discovery of the CD 206.7 for yourself? Check out the whole thing on the NIA's new Youtube channel by scanning this barcode with your smartphone, going to <https://tinyurl.com/bigclaw> or by searching for "National Insulator Association" on Youtube.



CD 109.5

NEW CD 206.7

CD 206.5



THE 53RD NATIONAL INSULATOR ASSOCIATION SHOW & CONVENTION

BANQUET & AWARDS



SOCIALIZING WITH FELLOW COLLECTORS AS WE WAIT FOR DINNER AND THE PROGRAM TO BEGIN



ELTON GISH (NIA #41) AND RICK BALDWIN (NIA #236) ARE TWO OF EIGHT NIA MEMBERS RECOGNIZED FOR 50 YEARS OF MEMBERSHIP. THE OTHER SIX RECIPIENTS - SHERRY KRELL, DOUG MACGILLVARY, JOHN DE SOUSA, DARRELL KARLIN, JOSEPH BERES, AND DICK BOWMAN - WERE UNABLE TO ATTEND.



DON BRIEL
NIA DISPLAY CATEGORY AWARD FOR "GENERAL"



DARIO DIMARE
NIA DISPLAY CATEGORY AWARD FOR "THREADLESS"



BILL & JILL MEIER
NIA DISPLAY CATEGORY AWARD FOR "SPECIALTY"



BILL SNELL
NIA N.R. WOODWARD AWARD FOR BEST DISPLAY USING NORTH AMERICAN THREADED GLASS

THE 53RD NATIONAL INSULATOR ASSOCIATION SHOW & CONVENTION



BANQUET & AWARDS (CONTINUED)



DARIO DIMARE
NIA MILHOLLAND EDUCATIONAL AWARD FOR BEST
SHOWMANSHIP AND EDUCATION IN A DISPLAY



ANDREW GIBSON
NIA PRESIDENT'S AWARD



BILL MEIER
2022 INDUCTEE INTO THE NIA HALL OF FAME



NATHAN HOLMES
NIA PRESIDENT'S AWARD



DON & JEANNE BRIEL
NIA LIFETIME MEMBERSHIP AWARD



RICK & BERNY BALDWIN
NIA LIFETIME MEMBERSHIP AWARD



THE 53RD NATIONAL INSULATOR ASSOCIATION SHOW & CONVENTION

BANQUET & AWARDS (CONTINUED)



BILL SNELL PRESENTS THE CHARLES BRANDON MEMORIAL AWARD FROM THE MISSOURI VALLEY INSULATOR CLUB TO BILL & JILL MEIER FOR THE BEST USE OF MIDWEST COLORED INSULATORS IN A DISPLAY



BILL SNELL RECEIVES THE JIM OVERSTREET MEMORIAL AWARD FROM BILL HALEY AND THE DIXIE JEWELS INSULATOR CLUB FOR BEST USE OF CDS IN A DISPLAY



MARY ANN PIKE RECEIVES THIS BEAUTIFUL DRAWING FROM THE GREATER CHICAGO INSULATOR CLUB AND BOB STAHR FOR BEST DISPLAY OF POWER INSULATORS (BELOW LEFT)



DARIO DIMARE RECEIVES THE PEOPLES' CHOICE AWARD FOR HIS THREADLESS DISPLAY - CLOSE UP BELOW CENTER



THE PEOPLE'S CHOICE AWARD COMMEMORATES THE 1863 BATTLE OF GETTYSBURG, COMPLETE WITH A FEW ARTIFACTS



THE N.R. WOODWARD LITERARY AWARD FROM THE LONE STAR INSULATOR CLUB WAS AWARDED TO CHRIS RENAUDO FOR HIS ARTICLE "CD 136 AND THE B&O TELEGRAPH COMPANY" IN THE JUNE 2021 ISSUE OF DRIP POINTS. BOB BERRY PRESENTS THE AWARD FOR THE CLUB, BUT CHRIS WAS UNABLE TO ATTEND

THE 53RD NATIONAL INSULATOR ASSOCIATION SHOW & CONVENTION



BANQUET & NIA AWARDS (CONTINUED)



A HUGE THANK YOU GOES OUT TO OUR SHOW HOSTS FOR ANOTHER GREAT NATIONAL.
(LEFT TO RIGHT) GUS STAFFORD, JUSTIN STOUDT, MARY ANN PIKE, EMILY STOUDT, AND STEVE GOSCIMINSKI

DISPLAY & CLUB AWARDS

Jim Overstreet Memorial Award
for best use of CDs in a display
by the Dixie Jewels Insulator Club
Celebrating 200 Years: 1822-2022
The Legacy of Samuel Oakman
Bill Snell

Charles Brandon Memorial Award
for best use of midwest colored insulators
by the Missouri Valley Insulator Club
Hemingray University
Bill & Jill Meier

Greater Chicago Ins Club Award
for the best display using power insulators
Pittsburg High Voltage and
Westinghouse Insulators
Mary Ann Pike

People's Choice Award
21 B.C. - Before Cauvet
Dario DiMare

NR Woodward Literary Award
for best published article by the
Lone Star Insulator Club
CD 136 and the B&O Telegraph
Company - Drip Points June 2021
Chris Renaudo

Best First Time National Displayer
by the Central Florida Insulator Club
21 B.C. - Before Cauvet
Dario DiMare

NIA Best of Show Award
21 B.C. - Before Cauvet
Dario DiMare

NIA NR Woodward Award
for best use of North American threaded
glass insulators in a display
Celebrating 200 Years: 1822-2022
The Legacy of Samuel Oakman
Bill Snell

**NIA Milholland Educational
Display Award**
for best showmanship and
education in a display
21 B.C. - Before Cauvet
Dario DiMare

NIA General Category Award
Galloway Insulator Root
Don Briel

**NIA Dr. Frederick L. Griffin
Memorial Award**
for best threadless exhibit, in lieu of the
threadless category award
21 B.C. - Before Cauvet
Dario DiMare

NIA Specialty Category Award
Hemingray University
Bill & Jill Meier

NIA Porcelain Category Award
Pittsburg High Voltage and
Westinghouse Insulators
Mary Ann Pike

NIA Foreign Category Award
Rare Mexican Insulators
Gilberto Hedges-Blanquez

NIA PERSONAL AWARDS & RECOGNITIONS

**50 Years of
NIA Membership**
Elton Gish - #41
Sherry Krell - #252
Doug MacGillvary - #259
Rick Baldwin - #336
John De Sousa - #419
Darrell Karlin - #440
Joseph Beres - #563
Dick Bowman - #597

Lifetime Membership
Rick and Berny Baldwin
Don and Jeanne Briel

Outstanding Service
Christian Willis
Ron Yuhas

National Show Hosts
Gus Stafford
Justin & Emily Stoudt
Mark Ann Pike
Steve Gosciminski

Lon C. Holy Award
Lincoln Roell

Hall of Fame
Bill Meier

President's Awards
Dwayne Anthony
Mike Green
Jack Nesbit
Nathan Holmes
Christian Willis
Andrew Gibson
Bill Rohde

DRIP POINTS CATEGORY AWARDS

North American Glass
The Montana Stacker
April 2021 Issue
Doug Rusher

Worldwide Insulators
The Not So Boring Cordeaux
Jun/Aug 2021 Issues
Jack Nesbit

General
Hemingray Odds & Dead Ends
Aug/Oct/Dec 2021 Issues
Christian Willis



You can watch the awards show yourself by scanning this barcode with your phone, going to <https://tinyurl.com/nia2022awards> or by searching for "National Insulator Association" on Youtube.

52nd MID-OHIO INSULATOR SHOW

November 4-6, 2022

Clark County Fairgrounds In Springfield, Ohio
Exit 59 Off I-70

*** SIMPLY THE BEST SINCE 1971 ***
125 Sales Tables (SOLD OUT) and 15 Displays

SHOW HOURS

Friday Noon - 6:00 p.m.
Saturday 8:00 a.m. - 5:00 p.m.
Sunday 9:00 a.m. - ?????

FREE ADMISSION

FRIDAY NIGHT AFTER-HOURS AUCTION
Begins at 6:15 p.m. Preview Friday 3pm - 6 pm

VISIT www.insulators.info/shows/springfield For Additional Show Updates and Dealer List

SHOW HOSTS

Lois Blair (740) 506-5536
Curt Boster (614) 301-5125 or cboster530@att.net

COMMUNITY DISPLAY:
First Insulator Obtained At A Show

2023 NATIONAL SHOW UPDATE

SHOW HOSTS DON AND JEANNE BRIEL * BRIAN & KATHY WEESE



2023 NIA National Show Update · Logan, UT · June 9-11, 2023

Registrations for the 2023 NIA National show are now being accepted. Over 100 registration packets have been given out as of the 1st of September, when this update was written, with many already turned in. Even more packets and forms are being accessed online. The show hall can accommodate up to 144 sales tables, 30 display tables, wide aisles, and a relaxation area. This promises to be a large show and we expect many walk-in visitors. It's been 5 years since the last tiny swap meet in Logan. Back then there were many local people showing up with high quality insulators to sell, wanting to learn more about them, and buying insulators. We're optimistic that even more insulators may show up this time around as well as many walk-ins wanting to buy. There also seems to be a growing interest among dealers in related hobbies (i.e. Bottles, Railroading, Signs, etc.).

The show will be held at the Cache County Fairgrounds Event Center on June 9-11, 2023. The building is new, spacious, and has amazing lighting for viewing insulators. Skylights let in daylight and are supplemented with ceiling LED lights. The building is air conditioned. There's plenty of free parking, easy access for loading and unloading, and about a mile from the host hotels. Restaurants, shopping, antique stores, etc. are all within a couple miles.



A Saturday evening banquet will be held at the Riverwoods Conference Center, adjacent to the host hotels, preceded by a social hour with live music and a cash bar.

An optional pre-show activity on Thursday, June 8th will be a bus excursion through rural Northern Utah to the Golden Spike National Monument and the Northrup Grumman (*Thiokol*) rocket display.

Please keep in mind that Cache Valley is a summer tourist destination and hotels quickly book to capacity. We have rooms being held at the Marriott Springhill Suites and Townplace Suites, our host hotels, for \$139/night. However, they are only being held until early April, 2023 when they will be released to the public and the special rate will no longer apply. The regular rate is currently listed at over \$350/night for these dates.



Other hotels in the area are listed in the registration packet, but they fill quickly as well.

Be sure to get this show on your calendar. Your attendance will help make it the best show ever. If your time permits, turn this into a wonderful summer vacation. There are endless things to do in the area and even more within a few hours' drive.

We are also now accepting donations for the silent auction. Many unique items have already been donated. Please send donated items to Brian & Cathy Weese or let them know of any items you plan to donate.

For complete show details and a registration packet visit: https://www.nia.org/shows/2023_national or contact your show hosts:

Don & Jeanne Briel
P. O. Box 188
Providence, UT 84332
(435) 753-5786
Don.Briel@comcast.net

Brian & Cathy Weese
909 North 170 East
Kaysville, UT 84037
(801) 201-5187
brianweese@gmail.com

COLLECTOR THREADS

FEATURING BILL ROHDE * NIA #1219 * BY MIKE GREEN

Despite the dangers in front of the vessel he piloted on toward an ominous wall of nature's fury. His skill and experience would be needed for what lie ahead. The passengers put their faith in his ability and hoped the perilous section ahead would lead to something both frightening and amazing. Something they had all paid to see. Ahead a dark wall of powerful wind and rain. Visibility would be very poor and giant hail was a strong possibility. As they entered the maelstrom the van was ponded by wind and rain. The road ahead was barely visible even with the wipers on full blast. It seemed insane but the adrenaline rush and thrill kept everyone focused. The driver knew that if could guide them through this pounding storm the other side might reveal a miracle of nature. Finally, after what had seemed like a long and dangerous stretch, they passed through to the other side of the wall. Suddenly the skies cleared, and they had entered a place so wild, so dangerous, that it is known as the Bears Cage. To the left was a towering 70,000-foot thunderhead and at its core grapefruit size hail. All around them veils of rain swirled in an eerie, circular pattern. To the right was one of the most astounding sights in all of nature. A towering vortex capable of producing winds in excess of 300 MPH. The gamble had paid off. After fighting their way through the wall of wind and rain there it was, a tornado. They call it the Bear's Cage for a reason. Occasionally a powerful storm develops a "hook" formation and on the tip of that hook a strong possibility of a tornado. They had punched their way through the hook into a pocket beyond imagination. Most people would be terrified to be trapped between a tornado and a massive thunderstorm. But these folks were thrill seekers, they had come from far and wide to be face to face with one of the wonders of nature. The man who skillfully led them there, the man who had all those lives in his hands, was of course our very own Bill Rohde. On that day and on other wild storm chases Bill proclaims, "I saw Dorothy"!

It all started many years earlier as a young boy growing up on the farm. Bill developed a fascination with storms from an early age. He began keeping records and learning about meteorology. Every time a big storm came, he wrote down all the details in a journal. One day he even saw a rare tornado in California and was hooked. Many years later he began driving for a storm chasing tour group out of Colorado. The tours normally lasted one week and would follow storms all over the Midwest. The big storms could be in Texas one day, Nebraska the next day, and Missouri the day after that. Many of those weeks racked up many thousands of miles with Bill behind the wheel. With every passing season Bill saw more tornadoes including some of the most famous. After 22 tours Bill has amassed an astounding 114 tornadoes! He has been on the cover of the Crown Jewels Directory at least 3 times standing in front of a twister. What's really cool is that the directory he's holding in the picture is also a picture of him in front of a tornado, and inside of that is yet another. It could go on forever!

Of course, storm chasing can be a risky business. A few years ago, three vans got a little too close. Bill, in the lead van somehow made it through okay. The other two vans were hit by cyclone force winds. One van rolled into a ditch, the other rolled several times into a field. Luckily no one was seriously hurt. There have also been many dents and destroyed windshields. Bill has handled it all in stride and is a bona fide expert storm chaser.



SPECTACULAR TORNADO



LACROSSE, KANSAS TORNADO



BILL IN FRONT OF TWIN TORNADOES WITH A CJ DIRECTORY

COLLECTOR THREADS

FEATURING BILL ROHDE (CONTINUED)



FIRST DAY OF SCHOOL



BILL AND SANTA

Our wild storm chaser came into the world in February of 1961. He became a fourth-generation farmer on the family Ranch in Clovis, California. As a toddler he remembers playing with matchbox cars in the furrows and helping to spot leaks in the dams. From a very young age Bill learned to work hard. He was given a half size shovel as a little tyke and always helped when there was digging to be done. In fact, he liked digging so much he once dug a 13-foot pit to see how deep the layer of gravel was! On the family farm they raised cotton, wheat, grapes, and almonds. He was always helping around the farm and learned a great deal. By eight years old Bill was driving a tractor and recalls learning to back up with mirrors at a very young age. Those years growing up on the farm built toughness and character. We certainly all know what a character he is...

Bill's family has always had a good relationship with the local Native Americans. It goes way back to his grandpa who always offered a helping hand and often employed them during harvest time. That positive relationship remains to this day.



BILL AND GRANDPA



CLOVIS RODEO PARADE



RIDING HONDA 50'S WITH A FRIEND



BILL LEARNED TO WORK HARD ON THE FARM FROM A VERY YOUNG AGE



BROKEN LEG. HAVING A CRUSH ON THE NURSE HELPED EASE HIS PAIN.

COLLECTOR THREADS

FEATURING BILL ROHDE (CONTINUED)

One night on the farm Bill was awoken by a big explosion and a green glow. Rushing outside he discovered lightning had just struck a pole near the house and the transformer was still arcing wildly. Already fascinated by storms he thought it was all pretty cool. It also brought attention to those funny things up on the pole. That was May of 1973 and yes, Bill started becoming interested in insulators. The next day PG&E came out to change the pole. Bill watched the entire process, and the workers gave him three Victor 648 insulators. On top of that grandpa had some insulators in the window so Bill was now hooked. He began searching everywhere for insulators. His searching eventually led to meeting Bill Heitkotter who took Bill to shows and became an early mentor. Bill became quite the wheeler dealer and started trading produce to PG&E linemen for insulators. Most of the produce he traded came from an eight acre garden he had built! Soon he had hundreds and hundreds of insulators. Along with collecting insulators he also became interested barb wire. Of course, school had to fit in there somewhere. Bill was an outstanding student and was in the National Honor Society. He did have his moments though. He recalls being chased by the principal one time while holding a bottle of wine in his hand. Luckily, he was a pretty fast runner. After high school he went on to Fresno State and Chico State Universities. He received degrees in Agriculture Finance and Business Management. During his time in college he continued to be focused academically and graduated Summa Cum Laude. Those college degrees serve him to this day. Bill works for a large bank and handles agricultural loans. His business skills combined with growing up on the farm give him a unique insight that make him very good at what he does. He says it is sometimes tough protecting the interests of the bank while also caring greatly for the hard working farmer.



GRANDPA DRIVING AND A VERY YOUNG BILL ON TOP TROMPIN COTTON



BILL AND HIS DAD WITH A 1968 CHEVY PICKUP



PROM

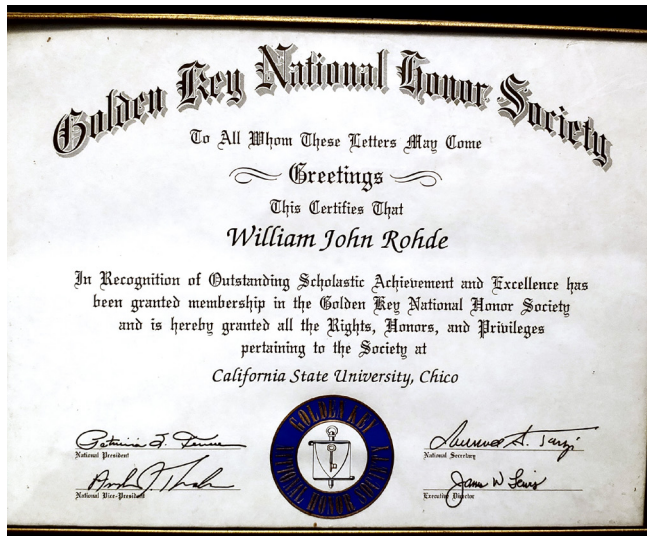

NATIONAL HONOR SOCIETY PHI CAPPA PHI CHICO STATE



SUMMA CUM LAUDE

COLLECTOR THREADS

FEATURING BILL ROHDE (CONTINUED)



BILL ON THE BIG TRACTOR



BILL WAS DRIVING ONE OF THE WHITE VANS YOU SEE IN THE PICTURE
YEAH, THAT'S BILL



BILL STILL HAS THIS PICKUP AND KEEPS IT IN PERFECT CONDITION

Among Bill's other interests is car racing. He started going to car races in about 3rd grade and fell in love with it. He started working on cars and found the mechanical skills he had learned on the farm very useful. Later he became part of a team and worked on Super Modified race cars for over 20 years. He also loves drag racing and has attended many NHRA events. He says there is nothing like standing next to a top fuel dragster with the fumes of nitro methane in your nostrils! Bill has also done some fine mountaineering including climbing Mt. Shasta. Somewhere near the summit of Mt. Shasta hides a Brookfield pony left there by Mr. Rohde himself! Thrill seeker Bill doesn't stop there. He also has gone skydiving over a dozen times including once with Dwayne Anthony who kept it a secret from Ophelia for quite sometime. LOL

Whatever Bill does he goes all out. Whether it is over 100,000 miles as a storm chasing tour guide or putting on a insulator show, Bill does it right. He learned to do things that way from loving and strong parents who taught him that hard work and detrmination pay off.



WHAT HAPPENS TO WINDSHIELDS WHEN YOU STORM CHASE



SUPER MODIFIED BILL WORKED ON

COLLECTOR THREADS

FEATURING BILL ROHDE (CONTINUED)



BILL AND MIKE WITH 5 FISHERS

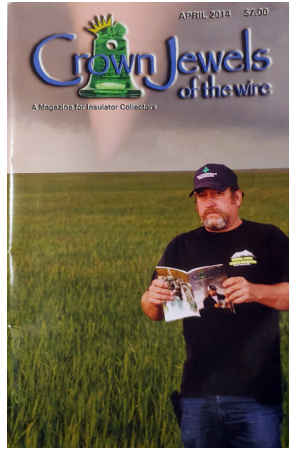

MORE TORNADO FUN



BILL AT A SHOW



LOTS AND LOTS OF INSULATORS



BILL AND HIS PARENTS AT THE ROHDE RANCH SHOW



BILL "REPLACING" A SIGN?



KAT PICKING ON BILL LOL



WITH WALTER RUEDRICH IN BAKERSFIELD



MIKE GUTHRIE WASHING A "TICK"

Over the years Bill amassed one of the largest and most complete porcelain insulator collections in the country. All of that collection now resides in Farmington, New Mexico as part of the Bolack Museum. He also has a fine glass collection including some of the best impurity pieces in the hobby. His love of the hobby runs deep, and he has served the NIA for many years as treasurer. He and his family have also put on one of the best shows in the country for over two decades now. This year marked the 26th annual Rohde Ranch Show and BBQ. For many years the show was a team effort with Mom and Dad. Bill misses that very much but he and Kat have carried on the tradition beautifully. Always a popular and fun event every collector should try to get there at least once. A new addition to this years Rohde Ranch show is an outhouse in the woods nearby. Bill and Kat brought it all the way back from Farmington last year after purchasing it from one of the displayers. For those who make a visit to the outhouse, it comes complete with corncobs. Always showing a good sense of humor Bill says the rough cobs are a nickle and the smooth ones are a dime... LOL

COLLECTOR THREADS

FEATURING BILL ROHDE (CONTINUED)



BILL AND KAT RECEIVING LIFETIME MEMBERSHIP AWARDS



LEAVING HIS MARK IN FARMINGTON



SKYDIVING WITH DWAYNE



BILL'S MOM AND DAD AT ROHDE RANCH



WORLD CHAMPION BARB WIRE
SPLICER 1985-1986



BOWLING TEAM WITH DAD AT THE NATIONALS



SUMMIT OF MT. SHASTA WITH INSULATOR



KAT WITH HAPPY DOG CHEYENNE

Bill has had a good life and he is always thankful for that. He says the hardest moment in his life was losing his Dad who had taught him so much about being a good man. There is little doubt that Bill's Father is eternally proud of his son. One of the best moments of Bill's life was standing on the summit of Mt. Shasta.

A great guy in every respect Bill's generosity and kindness are always on display. I got to see that first hand as co-host of the 2017 National in Colorado Springs. At the end of the banquet Bill announced that he would cover everyone's dinner in honor of his Mom and Dad. We were all blown away and humbled by his kindness. That's just the kind of guy he is. Honest, hard working, generous, and a wild man all rolled into one. His life is filled with great accomplishments and amazing stories. His dedication and service to the insulator hobby was acknowledged at last years National when he and Kat received Lifetime Membership Awards. Please join me in thanking Bill for sharing his wonderful life with us.

Happy Collecting and Power Off 🇺🇸

DIXIE JEWELS INSULATOR CLUB SUMMER SWAP MEET

BY MIKE HERRON * NIA #8618 AND BILL HALEY * NIA #8695

The Dixie Jewels Insulator Club held their summer swap meet on Saturday, August 20th, 2022 in Toccoa, Georgia at the Historic Toccoa Train Depot and Mitchell Allen Memorial Hall. The show was hosted by the Herron family (Tom and Brenda Herron, Casey and Andie Herron and Mike Herron). Many collectors from all over the USA attended the swap meet, and there were huge amounts of walk-in traffic and new collectors interested in the hobby that bought insulators, came for appraisals and several that left as new club members! The award for the collector who traveled the farthest went out to John Cashman of Palm Springs, California! He drove 2200 miles to join us along with his brother B.Z. Cashman from Blue Ridge, Georgia. Both Cashman brothers were life-long NIA members, with B.Z. being member #105 and John being member #106! There were over 20 sales tables with lot's of great insulators shown, traded and bought. Not only were there scarce and rare insulators available, but other collectibles as well, including bottles, crocks, Native American artifacts and other unusual items brought by Bill Johnson of Snellville, Georgia and Steve Ritter from Naples, Florida. Club members Dudley Ellis, Bill Haley, Dave Collins, Roy Hale, Ralph Dean, Ed Greenway, John Gasko, Jeff Kraemer and Bill Grieser all had large sales tables with great insulator deals to be had. Founding Dixie Jewels Club member and first president Keith Roloson of Cleveland, Georgia was also able to attend our swap with a nice selection of scarce insulators.



FOUNDING DIXIE JEWELS MEMBER AND PAST PRESIDENT KEITH ROLOSON FROM CLEVELAND GEORGIA WITH HIS NEPHEW GAVIN ATKINSON

A long-time Dixie Jewels member, Wiley Higgins, from Cumming Georgia, brought his ENTIRE collection to offer for sale in a silent auction, which included a nice CD 202 Green Fred Locke piece and a great 134 Purple W.G.M.Co! Congratulations to Chris and Doris Warwick of Martin, Georgia for the winning bid! Tom Herron of Toccoa, Georgia had a nice table of vintage Railroad and Telegraph signs for sale. Mike Herron, also of Toccoa, didn't bring any of his sales stock, but instead offered a 30% off coupon to collectors to visit his antique booth of over 1000 insulators just 2 blocks down from the show venue. Many collectors walked down and took part of that bargain! Brenda Herron prepared a fantastic noon meal of pulled pork BBQ with all the fixins! And as always, the homemade desserts were more plentiful than the main course! After lunch, we held a brief meeting with some great show and tell pieces. Club President Bill Haley showed off his CD 121 AM TEL & TEL Co. he got at the Gettysburg National that was almost perfectly clear! Roy Hale from Greenville, Alabama educated new collectors on fake and altered pieces with 2 irradiated insulators he brought and Ralph Dean also showed a fake CD 731 Tillotson threadless he found on Ebay. Thankfully he bought it cheap as a novelty item. We did have to share some unfortunately sad news about the passing of several Dixie Jewels Club members. Thoughts and prayers went out to the families of recently departed club members Gary Tilson of Madisonville, Tennessee; Gil Hedges-Blanquez of Seattle, Washington and Graham Barnes of Titusville, Florida. May their souls rest in peace. All-in-all, a good time was had by everyone and the show provided a nice encore from the Gettysburg National show that was held a few

weeks prior. Our next Dixie Jewels swap meet will be held in Eatonton, Georgia and hosted by Dave and Geny Collins! This will be the Dixie Jewels 30th Anniversary Show! Be sure to check out a Dixie Jewels swap meet in the future, because you will never be disappointed! The insulator hobby is still alive and well in the Southeast! 📌



THE SHOW FLOOR WAS BUSY EARLY! COLLECTORS ARRIVED AT 7AM!



RALPH DEAN FROM MILTON, GEORGIA (SALES TABLE)



BILL JOHNSON FROM SNELLVILLE, GEORGIA HAD CROCKS, BOTTLES AND OTHER GREAT COLLECTIBLES!



MORE OF THE SHOW FLOOR!



DUDLEY ELLIS FROM STOCKBRIDGE, GEORGIA HAD SOME "BARGIN" PRICES!



CASEY AND MIKE HERRON TALK TO A NEW COLLECTOR!



MORE OF THE SHOW FLOOR!



TOM HERRON FROM TOCCOA, GEORGIA TALKING ABOUT HUNTING INSULATORS!



WILEY AND HELEN HIGGINS FROM CUMMING, GEORGIA MANAGING A SILENT AUCTION ON THEIR ENTIRE COLLECTION!



BILL GRIESER FROM KERNERSVILLE, NORTH CAROLINA WAS ALL SMILES AFTER MAKING GOOD SALES!



ANDREW MIKA OF ANDERSON, SOUTH CAROLINA HELPS JEFF KRAEMER OF MAULDIN, SOUTH CAROLINA AT HIS SALES TABLE!



JOHN CASHMAN AND B.Z. CASHMAN AT THEIR TABLE. JOHN TRAVELLED FROM CALIFORNIA TO JOIN US!



HEIDI AND BRADY HERRON SHOW OFF THEIR INSULATOR FINDS! IT'S GREAT TO SEE KIDS ENJOYING THE HOBBY TOO!



CHRISTINE AND STEVE RITTER FROM NAPLES, FLORIDA



RALPH DEAN FROM MILTON, GEORGIA AND TOM BLATNIK FROM WOODSTOCK, GEORGIA



JEFFERSON STATE INSULATOR CLUB'S BEND OREGON SWAP MEET

BY HOWARD BANKS * NIA #900

Weather was perfect for the Bend, Oregon Insulator Swap Meet held on August 12 & 13. The temperatures in the mid-80s and we enjoyed clear, blue, sunny skies. Attendance was lower than last year, but that gave the show an intimate feel. We counted 50 folks in attendance over the two days, with participants coming from Montana, Idaho, Washington, California, Utah, and Oregon.

Attendees told the show hosts they enjoyed the event very much; dealers seemed pleased with their sales; and a lot of us had plenty of time to swap insulator hunting stories and other tall tales.

The Bend show will be held again next year on August 11-12, 2023.

Photos courtesy of Howard Banks and Mid Norris



SATURDAY'S EARLY RISERS



GOAT GOT YOUR GLASS?



DAVE MOFFATT AT HIS TABLE



JUSTIN MARTIN WITH HIS NEW BABY, A MINT GRAY M-4395



THE "SHARKS" GATHER AS BRIAN SMITH UNPACKS THE INSULATORS HE BROUGHT TO SELL



(LEFT & ABOVE) MID NORRIS' TABLE AND BIG MUD



JOANNE WOOD RELAXES IN THE SHADE



GARY BOYD, CODY SIMMONS, DAN DIMMON, TIM WOOD, JUSTIN MARTIN, DAVE MOFFATT, AND PETER ABBOTT (BACK TO CAMERA) CHECK OUT THE OFFERINGS AT A TABLE. LOOKS LIKE DAN IS CONTEMPLATING THE PURCHASE OF A CD 130



BRIAN SMITH'S TABLE

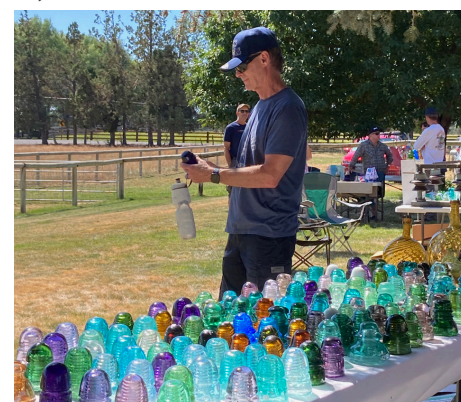

NEW COLLECTOR MIKE FACER INSPECTS AN INSULATOR IN THE SUNSHINE BEFORE DECIDING ON WHETHER TO BUY IT.



WANTED



To Buy Singles or Collections

Glass and Porcelain Top Prices Paid



Also WANTED TO BUY any Power Company Signs,
Lineman's Tools, Birdhouse Fuse Boxes, Early Line
Construction Tools, Shotgun Sticks, Early Transform-
ers, Old Meters, Old Switches, Early Arresters, Early
Cut Outs, Any Thing you think I might be interested
in, PLEASE CALL

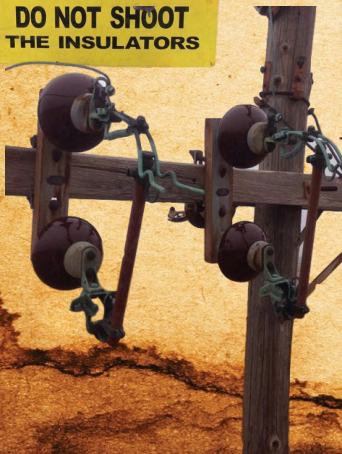

Jason Townsend

jtins@gmail.com

Cell (630) 667-3357

720 N. DeKalb Street

Sandwich, IL 60548



DID YOU KNOW?

BY DON BRIEL * NIA #7218

Did You Know?

me, but it's not the easiest question to answer in non-technical terms. The quick answer is those things up on the telephone poles that hold the wires. But then the next

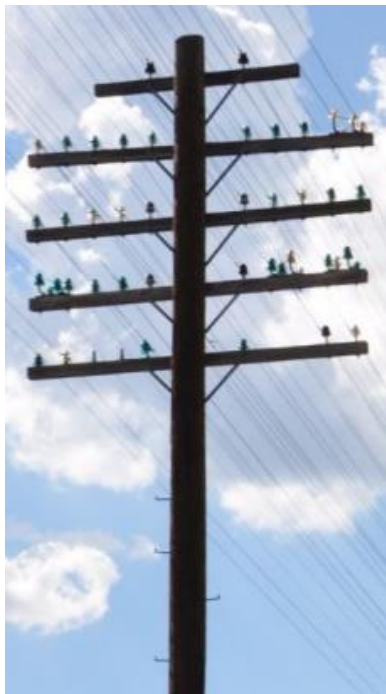

So, you are now an insulator collector! Well then, exactly what is an insulator? When I'm asked this question, the answer is most obvious to

question is, "What's their purpose?"

Soooo -- while keeping things as simple as possible here's a round-about answer. The dictionary definition of "insulate" is "to cover, line, or separate with a material that prevents or reduces the passage, transfer, or leakage of heat, electricity, or sound". Although most electrical insulating material is also a good heat insulating material, our focus will be on electrical insulation. The

two most basic requirements that must be accommodated when working with electricity are a means to pass, or conduct, electrical current to where it is needed and prevent, or insulate, electrical current from flowing to where it is not supposed to go. Both of these requirements and their solutions can be found in every electrical device and application. They range from the microscopic elements of micro-electronics to the huge wires and insulators found in electrical power transmission. This article will focus on the above ground transmission of electricity for power (*homes, factories, electric trains, etc.*) and signaling (*telegraph, telephone, railroad signals, etc.*), both of which use the insulators that we collect.

Wire is the most commonly used conductor, or way of delivering electricity to where it is needed. Wire is metallic and most often copper or aluminum. However, early

telegraph applications used steel wire for strength and later copper coated steel wire for strength and better conductivity. In the case of the insulators we collect, the insulator is placed between the wire and the wood or metal pin that supports it.



A typical electrical circuit is a complete loop where electrical current flows out from a power source and back again (*i.e. from a positive battery terminal via wire, thru a light bulb, and back to the negative battery terminal*).

The voltage (*volts*) of the source (*battery or power line*) times the current (*amps*) determines the amount of power (*watts*) that is consumed.

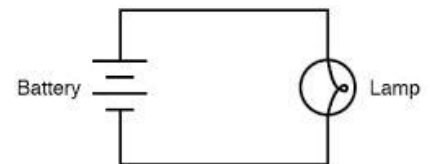

The power consumption of a light bulb, and other electrical devices, is generally measured in watts. When current flows through the circuit the light bulb glows and electrical power is consumed. Voltage is primarily what determines the size of an insulator, particularly the surface distance from the conductor to the mounting pin.

The CD 327 shown, and other large insulators like it, have long distances from the conductor to the mounting pin allowing for high voltage operation. Current is what determines the wire size and thus the size of the wire the insulator must support. Insulators like the CD 267.5 were made for very high current (*i.e. electric trains*) and relatively low voltage. They must also support the weight of the heavy conductor wire.



CD 327



CD 267.5

DID YOU KNOW?

(CONTINUED)

Now, back to the light bulb circuit -- If the wire going to the light bulb ever comes in contact with the wire coming back from the light bulb, we have a "short circuit" or failure of the circuit. The light bulb offers resistance (*Ohms*) to the flow of current thus limiting it. A short circuit offers very



little resistance causing arcing, blown fuse or circuit breaker, melting of the wire, and possibly a fire. That is why the wires must be insulated. Today, most electrical

wire (*insulated wire*) has non-conductive material around the metal conductor to insulate it (*i.e. house wiring*). In the early days of electrical circuits bare metal wire was used exclusively and insulated with the insulators that we collect today. As you are already aware, these insulators come in many forms including glass, porcelain, composite, wood, etc. Bare wire is still used today in above ground power transmission lines, but rarely used elsewhere. Most communication lines now use insulated wire and are buried underground. Even those are rapidly being replaced with



fiber optic cables that do not carry electrical current and do not require any electrical insulation. Radio waves, or wireless, is another replacement for wire.

The basic role of insulation in the light bulb example is typical of nearly all electrical circuits. When it comes to

high power applications such as power transmission, the result of a short circuit can be catastrophic. A short circuit can occur when power lines touch each other, break and reach the ground (*earth ground is an excellent conductor, particularly when wet*), contacts

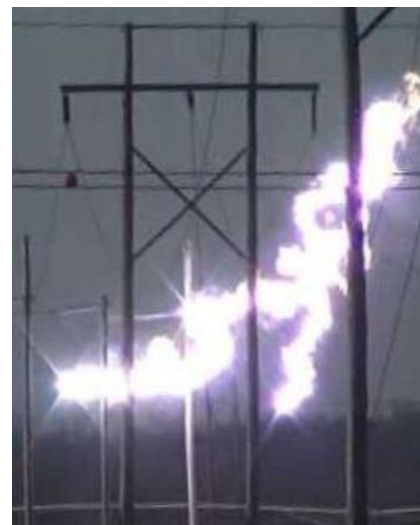

another object, an insulator cracks and lets water in, etc. A shorted power line can start a fire, kill a person or animal, waste enormous amounts of power, and cause widespread power outages. In the case of signaling, a short circuit shuts down the entire signaling function of the line.

Now that you know a bit more about what an insulator really is and what it does, maybe the better answer to "What is an insulator?" should be a device that prevents electrical catastrophes. Without insulators we would not be able to control electrical power. We would not have all of the modern-day conveniences that electricity affords us. While electrical insulation now comes in many forms, the insulators that we collect are attractive tokens of a bygone era that our children and grandchildren may never relate to. Let's continue to preserve this piece of history and educate our friends.

*May Your Collecting be Safe,
Educational, & Enjoyable!*

2022 CAYUCOS INSULATOR SHOW REPORT

BY BOB MERZOIAN * NIA #3941

After a two year hiatus, the 28th Annual Cayucos insulator show was held in late May. For many years the show had been set in the Veterans Hall next to the Cayucos pier, until four years ago when the building was closed to the public due to some structural damage. Fortunately, the large adjacent outside patio/ barbecue area was still available for public usage. And then the Covid epidemic hit America...wham, the patio (for all events) was indefinitely closed.

The epidemic waned and San Luis Obispo County restrictions were relaxed. Determined to revive the show, Bob Merzoian began working with venue overseers six months ago. Breck Smith, coordinator with the Lions Club who oversees the facility, approved this year's May 21st date. It was also announced that a new, remodeled and enlarged building plan has been approved and funding is being raised in hopes that construction will begin early next year. In- the-meantime, it is hoped that the show will continue to be held on the patio, until the new building is opened.

May 21st arrived and Cayucos was blessed with near perfect weather. The backdrop to the patio is the Pacific Ocean. The beach was crowded, surfers enjoyed bigger than normal waves, and insulator collectors were happily "working" their tables. Twenty-one tables filled the patio. Busily working dealers included Steven and Tina Reilgelman, Paul and Kathy Greaves, Pete Fortier, Terri Blasingame, Colin and May Jung, Richard McLaughlin, Curt Randles, Bob Merzoian, Richard Hawkins, Paul Frydendal, and Bob McLaughlin.

All sellers reported strong sales. They were pleased with the steady morning stream of "walk-in" customers. Many were curious tourists visiting Cayucos for a day at the beach, hikes in the hills above the town, window shopping along the quaint downtown streets, and just enjoying the little getaway town.

Comments ranged from "What are those things?," "What are they worth?," "Wow! The colors are really nice.," and more. Dealers readily answered their queries, which resulted in many happy customer purchases.

As lunch was served, the general conversation pointed to a resounding "Yes" to the questions concerning participating in the 2023 Cayucos show. The patio set- up was deemed successful and would serve the insulator pastime well until the building renovation is completed. All agreed it was wonderful to have the revival of this year's event. The hobby continues to revive itself with tailgaters, local shows, and National Events. Friendships are being renewed. And the public continues to discover our "jewels". You just can't keep a good thing down. 🍷



MY SET-UP CREW: ROSEMARY MERZOIAN,
KARSON AND KARTER CEJA

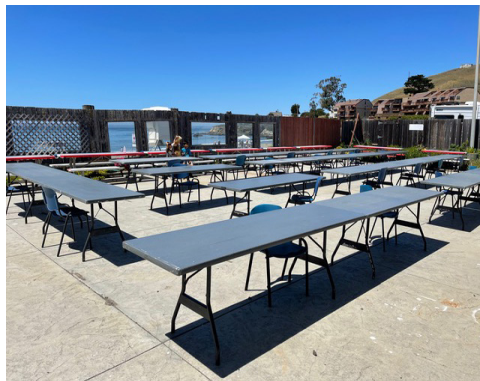

READY FOR THE DEALERS



STEVEN REILGELMAN CHECKING
OUT THE WARES



CURT RANGLES



RICHARD HAWKINS



COLIN AND MAY JUNG

2022 CAYUCOS INSULATOR SHOW REPORT

(CONTINUED)



RICHARD DAWSON



A LONG SHOT



NEW YOUNG COLLECTOR



PAUL AND KATHY GREAVES





TERRI BLASINGAME WITH HER CREATIVE CRAFTS (NOTE THE INSULATORS)



DAVE BROWN, PAUL FRYDENDAL, & PETE FORTIER

SPECIALIZING IN
INSULATORS
FROM OUTSIDE
NORTH AMERICA
BUY ~ SELL ~ TRADE



NATHAN HOLMES
MAVERICK@DRGW.NET
719-235-1286
NIA #4002



WANTED

CD 293's & CD 288's in All Colors and
Especially Character pieces
Also photos of 293's and 288's in use,
Historical info etc.
Doug Rusher NIA1773
Helena, Mt 59602
PH 406-461-7341 or ddrusher@aol.com

THE INTERNATIONAL INSULATOR COLLECTORS MEETING

BY JAMES BANCROFT AND PHOTOS BY STEFAN HAUNSTETTER

The International Insulator Collectors Meeting finally took place in Krefeld, Germany between July 8th-10th. Originally scheduled for July 2020 the show had to be postponed due to the pandemic. It was rescheduled for the following year with the expectation that the pandemic would have subsided but continuing infections and lockdowns meant a second postponement was inevitable. So again it was put back until the summer of 2022 when eventually the show would go ahead regardless.

The event was well attended with collectors from eight European countries in attendance. These were Czechia (The Czech Republic), Germany, Hungary, Italy, Netherlands, Spain, Sweden and the United Kingdom. Whilst most collectors drove to the show I flew to Dusseldorf and walked the ten miles to Krefeld. However, the most determined traveller was Paolo from Italy who cycled the 600 mile journey in four days. It was great to see so many familiar faces again after a four year absence along with collectors for who this is their first event.

The venue for the show was a former Cognac distillery known as Weinbrennerei Dujardin which is now a museum and restaurant. The first day was spent setting up the show and offloading the insulators. After this we enjoyed some food and German beer beside the river in the evening sun.

Saturday was the main day when trading of the insulators took place. As is the tradition with shows in Europe there is no money involved which is a system which has worked well since I attended my first such event 15 years ago. After the insulators were traded the show wound down and a guided tour of the museum was given. German tax laws made production of liquor uneconomic so production moved to France. Most of the equipment remains in place and has been well preserved. We were also given a small taster of the company's cognac. Later that evening we enjoyed a meal at the museum's restaurant.

On Sunday I made the return journey to Dusseldorf by foot to catch my flight home. For those staying longer some tours of nearby attractions formed part of the show itinerary. Show host Marco Schmitz-Le Hanne did a great job in putting on the show. I first met Marco at the 2004 National in New Kensington, PA.

The next European show is scheduled to take place in Hungary in 2024 to be hosted by Zoltan Drinoczi at his large field in the south of the country. I will be there and I hope you will be too. 🇳



BOTTOM ROW (L-R)

1. MARIO STOEPLER
2. FREDRIK HÖJEFÄLT
3. CRISTOBAL LUENGOS
4. JUDITH WANZER (HERBERTS WIFE)
5. SHOW HOST MARCO SCHMITZ-LE HANNE
6. HERBERT JUENGLING

CENTER ROW

7. PYTE
8. LAMBERT DRISSEN
9. MARLENE DRISSEN
10. LOTHAR VORMWALD
11. MIKLOS MOSER
12. VIOLA KARDOS

CENTER ROW CON'T

13. FRIEDMAR KERBE
14. UNKNOWN - NEXT TO FRIEDMAR IN THE HAT
15. SIEGFRIED MÜLLER
16. DANIELE VORMWALD
17. STEFAN HAUNSTETTER

TOP ROW

18. FRANTIŠEK DANĚK
19. ZOLTÁN DRINÓCZI
20. JÖRG KOGEL (MUSEUM MARGARETHENHÜTTE)
21. GUNTHER ASELMAYER
22. UNNAMED NEW COLLECTOR
23. JAMES BANCROFT

THE INTERNATIONAL INSULATOR COLLECTORS MEETING

(CONTINUED)



CRISTOBAL LUENGOS TABLE



FRANTIŠEK DANĚK TABLE



FREDRIK HÖJEFÄLT TABLE



GUNTHER ASELMEYER TABLE



SHOW ACTIVITY



LOTS OF ACTION AT ALL THE TABLES



SHOW ACTIVITY

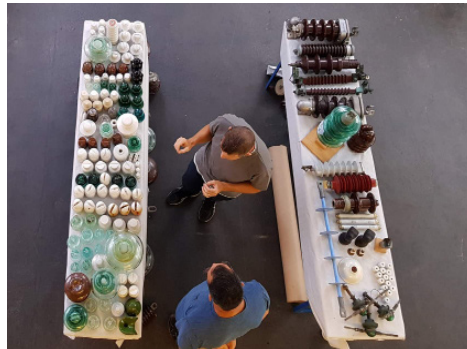

OVERHEAD VIEW OF SALES TABLES



LAMBERT DRISSEN TABLE



LAMBERT DRISSEN TABLE



LOTHAR VORMWALD TABLE



MARCO SCHMITZ LEHANNE TABLE

THE INTERNATIONAL INSULATOR COLLECTORS MEETING

(CONTINUED)



SHOW LOCATION



FUSE CUTOUT



TOP VIEW FUSE CUTOUT



SHOW FLYER



STEFAN HAUNSTETTER TABLES



STEFAN HAUNSTETTER TABLES



STEFAN HAUNSTETTER TABLES



ZOLTÁN DRINÓCZI & MIKLOS MOSER TABLE



ZOLTÁN DRINÓCZI & MIKLOS MOSER TABLE

BY MICHEL BRUNET * NIA #9331

Here's the history behind the discovery of the CD-120 No Name "010" MLOD MLOB Round base, Jade Green (F-Skirt) Rd No 156417 (R-Skirt) 9 with a factory ground base.

What we know so far is, it was dug out in a dump near Belleville Ontario in the 1970s. My friend bought a bottles collection from an elderly digger who remember digging it with a bunch of bottles. After cleaning all is new stuff, he looked at the 120 and there was only number on it, he looked in the price guide and was not listed, he did more research, talk with friends, and finally concluded, that was a unique piece, never seen before.

In 2018, I received a call from my friend, he told me he had bought a bunch of old bottles and insulators, he explained to me that he has found what he think was a new insulator, I went to visit him to see this rare beauty in person. After long discussion, we agreed on a price, and I bought it.

Now it's in my display and it will be in my collection for a while.

Michel Brunet, Québec, Canada



THE CD286 LOCKE FLATTOP

INSULATOR SPOTLIGHT BY DOUG RUSHER * NIA #1773 * PART 2

KEN WILICKS & JEFF KATCHKO F.M. LOCKE CD286 PROTOTYPE FROM THE ATTIC DIG

A excerpt from Elton's Great article on the Attic Dig if you would like to read more on the attic dig please go to elton's web site for the complete article https://www.r-infinity.com/Fred_Lockes_Attic/index.htm

Jeff Katchko and Ken Willick have been digging a site that we think could be where all the insulators in Fred Locke's attic were dumped when his house in Victor, NY was sold in 1953 to Jake Garvey. I talked to Mr. Garvey in 1993 during a research trip for my book, Fred M. Locke: A Biography. He said the attic was full of all sorts of papers from Fred Locke's insulator business and a large number of insulators. It seems Fred Locke never threw anything away that could be used to support his experimentations and patents. When Mr. Garvey and his sons cleaned out the attic, all the insulators were dumped someplace and all the papers were burned in a huge bonfire. J. Sheldon Fisher heard of the unfortunate incident and rushed to the site of the bonfire, but only managed to save a handful of letters. After nearly three years of digging at an undisclosed location, Jeff and Ken have decided to show many of the insulators and other items in 2006 at the NIA National show in Austin, TX in June and the Mid-Ohio Insulator Show in Springfield Nov. 4-5. There will be about 15-18 new U-numbers assigned. This is probably the most exciting find in the history of porcelain insulators -- and there are glass insulators, too. We knew Fred Locke was a prolific inventor and experimented with many different insulator designs and manufacturing techniques, but the "attic dig" has uncovered a vast display of just how prolific he was beyond our previous expectations.

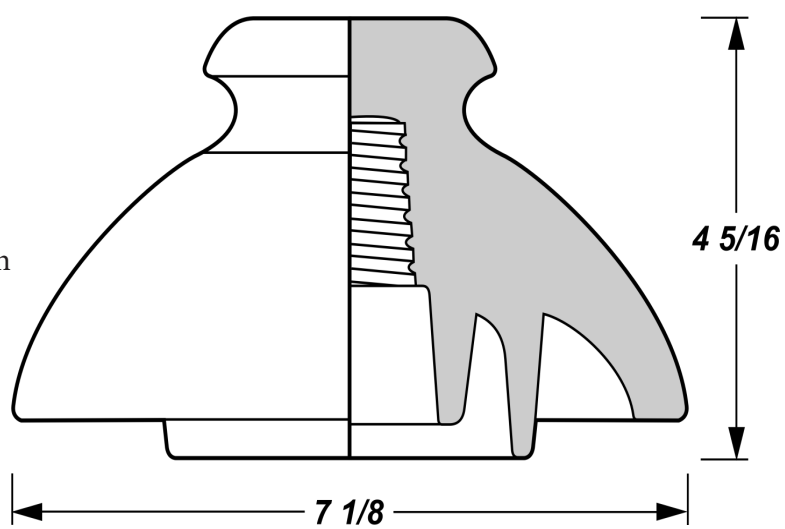

The above line drawing and photo are of the CD 286 Prototype dug at Locke's Attic Dig, as you can see the skirt is not as rounded as the CD 286, There was no new CD number issued for it. as its so close to the original CD 286, on the right is the (M-2201) Porcelain answer to its glass counterpart it's the only one know and was designed to use a porcelain or Glass inner sleeve, can you imange how great this would have looked with a glass inner skirt. I created a mockup of what it could have looked like on next page



THE CD286 LOCKE FLATTOP

(CONTINUED)

THE M-2201 INK STAMPED LOCKE FLATTOP PORCELAIN

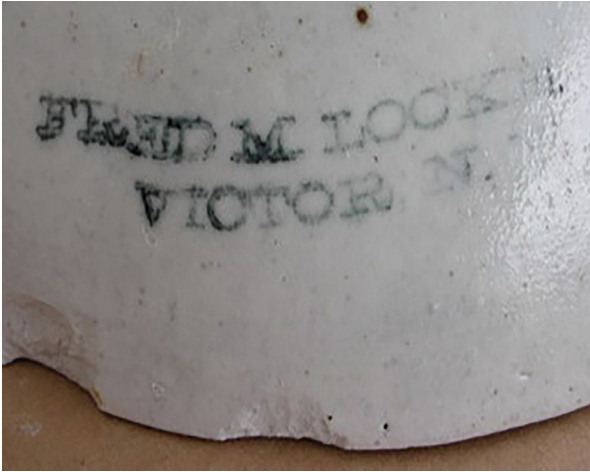

THE FRED M LOCKE VICTOR N.Y. INK STAMP MARKING



HERE'S A STANDARD CD-286 COMPARED TO THE M-2201



NOTICE THE INNER RIDGES OF THE M-2201 TO HOLD SULPHUR OR CEMENT THE THE ADDED INNER SKIRT



The above photo is a MOCKUP that I made of how the M-2201 might of looked with a glass insert, We know that Fred Locke worked on many glass and porcelain combinations of insulators. He also had Glass Tops that were designed to be used with glass or porcelain inserts.



M-2201 from the Locke Attic dig. This is listed as a multipart but could have been intended as a glazeweld. Still no further info, as of this date.

THE CD286 LOCKE FLATTOP

(CONTINUED)

CD-286's in use



25TH ANNUAL HAWKEYE INSULATOR SWAP MEET

BY BILL SNELL * NIA #2624



Another one for the books! The 25th Annual Hawkeye Insulator Swap Meet was held at the historic Hotel Pattee in Perry, Iowa, on Saturday, June 4, 2022. The meet was attended by several notable “glass-heads” across the region. The weather, accommodations, and the food were splendid, and on behalf of Tom Murphy, Ben Tucker, Dave Shaw, and myself, I want to thank the hotel staff for their “Iowa nice” hospitality.

Several incredible pieces were here on display and for sale, including a smooth base CD 162 H.G. Co. in cobalt blue, a yellow CD 145 HG Co., and a medium amber CD 145 H.G. Co. Naturally, there were an array of many blues, ambers, green, and purple shades and CDs on display. There were also several telephone related items for sale including phones, porcelain signs, as well as railroad lanterns.

Approximately 200 people attended, which included 23 collectors who set up for the event.

The insulator hobby is strong, which is a reflection of the friendships and the integrity of the people that attended this special day!

Next year’s Hawkeye Insulator Swap meet will head home to Tama, Iowa, and will be held on June 3, 2022 ...more to come! 🏠



EBBW VALE STEEL IRON AND COAL COMPANY POWER LINE - PART 2

BY JACK NESBIT ~ UK DRIP POINTS STAFF WRITER

Back in March my friends (Richard and Jake) and I embarked on one of our week long hunting trips in the wilds of Wales, searching long abandoned power lines in the hope of discovering the weird and wonderful first generation insulators.

We made the brave choice to camp for the whole week near a remote “A” pole line built by the Ebbw Vale Steel Iron and Coal Co., and planned to spend the whole second day hunting here. I wrote an article on the same line back in 2020, where we found some fantastic Bullers Hewlett insulators. The hunting ground was fantastic, and we had only covered a small portion of the line.

The original pin type insulators used by the EVSI&C Co. were a pattern that has been on my personal bucket-list for a long time – two piece cemented deltas with the “BULLERS Ltd. LONDON” text marking. These deltas are really the origin of what we know as the Bullers P5065. The text marking (originating around 1898) was superseded by the hand holding an insulator logo sometime around 1910-1912, meaning any power insulator with this marking is slap bang in the right era. So, on with the hunt!

It was an early start, and after a chilly night in the tent we were eager to get walking. Directly behind the campsite was our hunting ground, which promised to hold all sorts of interesting finds.



PICTURE 1

First we walked along to the old colliery site which the power line had fed, before we cut up a steep path and intersected the old cutting where a number of stumps for the original A poles soon became visible. On the ground were some exciting fragments of what we were looking for; the “BULLERS LTD. LONDON” delta types with a dark brown, speckled glaze (Picture 1). There were pieces of Hewletts too, but no brackets or poles.

We decided that our best chances were probably in searching thoroughly below the pole sites for some distance, as the steep terrain meant that discarded insulators and brackets had rolled downhill – something we had discovered on our last hunt of the EVSI&C Co. line in 2020.

While Richard rested and looked around a pole stump, Jake and I ventured off into the trees to search. Our theory was soon proven as nestled against a fallen tree under a blanket of spruce needles were three brackets, one containing a lovely ink stamped Bullers delta in mint condition (Picture 2).



PICTURE 2

A little further up, the line took a sharp turn and ran along the hillside. The corner pole was lying in pieces, with some 1930s and 40s hewletts scattered on the ground around it. A fantastic find here was one of the original cast iron danger signs, massive beasts that are in no way rucksack friendly! The pole contained a lovely pair white porcelain spools too, which were duly rescued (Pictures 3 and 4).

Picture 5 shows a standing A pole with three short arms, and a single modern replacement pole further on behind it. Picture 6 shows a discarded string of hewletts found close to one of the pole stumps. The line was now becoming harder and harder to follow and it seemed that forestry operations had obliterated all trace. It's sad to see an untouched line churned up like this, but as it soon became apparent, there was a silver lining to it all.

In between messy lines of trash were patches of quite bare ground where the spruce trees had been; this meant that any surviving insulators were now easier to spot. The remains of fallen pole with a single hewlett hanging from the arm pointed us in the right direction.



PICTURE 3



PICTURE 4

It was here that I decided to scramble downhill as far as the next forestry track, and then zig zag back up below the pole site. Jake joined me with his camera. The first find was actually close to the pole and quite a rarity – a lovely little composite spool (Picture 7). There were some broken hewletts further down too, and fragments of 1960s deltas, but nothing too exciting. Then I got a real shock as I turned around and was suddenly confronted with the sight of a delta half buried in the slope – a dark glazed BULLERS Ltd. LONDON one! Was the search finally over?! I performed a dramatic reveal and unearthed the treasure, and it was whole! Despite a few hairline cracks this early beauty had survived both it's tumble down the hill and the forestry machines.



PICTURE 5

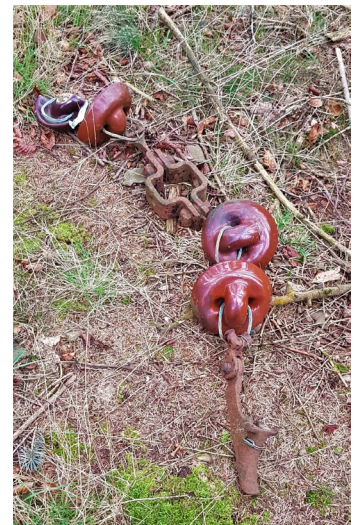

PICTURE 6

EBBW VALE STEEL IRON AND COAL COMPANY POWER LINE · PART 2

(CONTINUED)

Jake snapped a picture of me seconds after pulling the insulator out of the ground (Picture 8), the big grin followed a bit later! Picture 9 shows the insulator on the ground. The finds continued after this, and we discovered three broken apart deltas below the next pole site. These were all marked with the early logo and have a mix of lighter brown glazes (Pictures 10 and 11). They all have a 3/4" cordeaux threaded pinhole, another sure sign of their age.

The hillside shortly revealed yet more broken deltas, and I'm pleased to report that we managed to save a handful of BLL and logo marked examples for repair. Amongst these insulators were some more bizarre fragments which have raised a few questions. Fragments of a much earlier and smaller type of delta (Picture 12), some sort of large European made slot top insulator and bits of white Curtoys pattern. Perhaps the Bullers Ltd London deltas were not the original insulators used on this line afterall, which would make it a bit earlier than we first imagined. We'll solve the mystery one day, for now though, on with the hunt.

It was about mid morning, and we stopped at a forestry track for a break. From there, the old cutting ran through untouched forest and was a bit more gentle to follow. Picture 13 shows one of the old poles as it was left. We had spread out across the hillside to search a wide area again, and while I was taking picture 13 I heard Jake and Richard shouting me from further up. Jake had found something exciting!



PICTURE 9

I rushed up through the trees and saw them sitting beside the find. It was a gorgeous early delta, resting in the leaf litter not far from the A pole stumps (Picture 14). This one was much smaller and more dainty than the BLL P5065 ones, and we quickly realised it was a pattern none of us have seen before. We think it is the first one to appear in the hobby. It is a two piece insulator with a 3/4" cordeaux threaded pinhole, and the pattern number (P3510) is stamped on the crown along with the early Bullers logo.

This was the last great find of the day, but the rest of the line was certainly enjoyable to hunt. Both sides of the large valley that the line crossed held very little apart from broken P5065 and P5064 deltas (Picture 15). Buried halfway up the valley side however, was a second cast iron danger sign in great condition. I've no idea what the locals thought as I carried it through the town on our way back to the campsite!

By the time we descended the last hillside towards the "start" of the line, it had become apparent how lucky we had been earlier in the day. Every old insulator that we found after the P3510 was heavily damaged. We saved a few more good condition tops, but struggled to find any good inners. One top is shown in picture 16; that isn't mud smeared on it, it's the glaze!

I've no doubt that there are more complete insulators buried along this line, and we will return for an even more thorough search soon enough. There is still a lot of mystery as to the actual age of the line though, and the original construction. We now suspect that it was only single circuit to begin with, although the mix of different sized insulators is unusual. Perhaps the second circuit was added a little later and run at a different voltage?

Despite there being virtually no documentation of these early UK power lines, it is really exciting to discover again and again that the timeline seems to go back further than we think. Every line holds surprises and gives up tantalising clues that keep the hunt fresh!

Camping "on location" was a great experience too, waking up early and being able to walk straight out and explore an area rich in all kinds of insulators. I'll write a bit more about our trip in my next articles.



PICTURE 10



PICTURE 11



PICTURE 14



PICTURE 12



PICTURE 13



PICTURE 15



PICTURE 7



PICTURE 8



PICTURE 16



JAKE RIDEOUT'S P3510 DELTA

EBBW VALE STEEL IRON AND COAL COMPANY POWER LINE - PART 2

(CONTINUED)

A snippet of history about the Bullers "delta" insulators...

In my article I mention Bullers P5065, P5064 and other patterns that we call "deltas". This general style was developed between 1900 and 1910, around the same time similar US and European types were first being used. Picture A shows a sketch from an early article illustrating the comparison, with what we call the classic UK delta pattern on the left. While these will have naturally evolved from the early triple shedded mushroom patterns, it is clear there was also a lot of home-work copying going on between engineers!

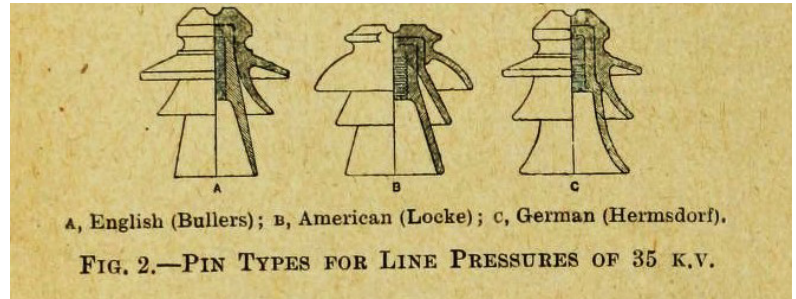

PICTURE A

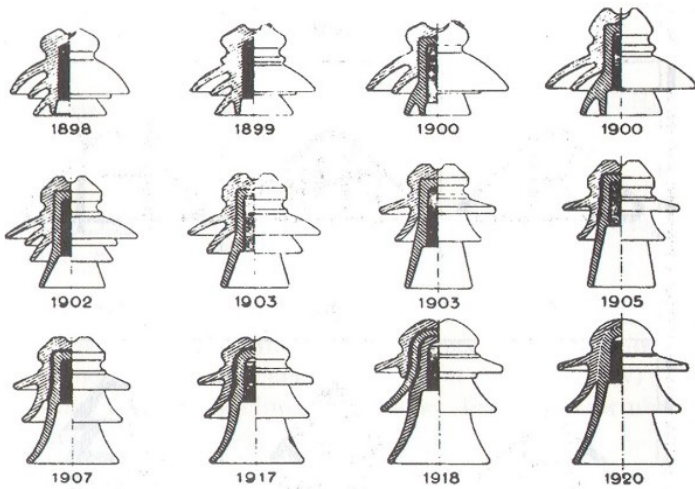

PICTURE B

The "true" delta style was originally developed in Europe just before 1900 and looked a lot different to start with (Picture B), but the name seems to have spread to cover most of the large triple shedded power pin types. The Bullers Ltd London marked example found in Wales is a good representation of what the first British versions looked like, with a chunky square crown, wide top shed and long straight inner. The inner - or lower portion - was usually separate, with the crown and top two sheds being one piece. The two halves were then cemented together, as shown in Picture C. Also note the drip edge on the top shed, which can be found on nearly all of the larger deltas.

Bullers incorporated a strict pattern numbering system quite early on, which is where the P. numbers come from. The most common series of delta patterns that we find here are the P506- numbers, ranging from the P5063 (the smallest) to the P5067 (the monsters). Picture D shows the robust P5064 pattern, with a shallower crown and relatively small top shed. The ink stamped example shown in the article is a P5064, which was later made as a unipart as with many others.

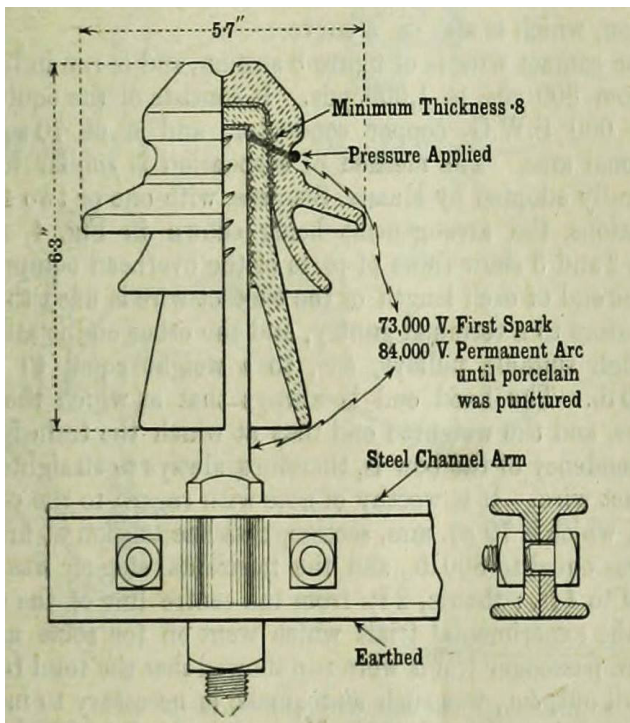

PICTURE C

The P5065 is the closest in proportions to the Bullers Ltd. London and early logo pieces we found on the EVSI&C Co. line, and a similar example (found in 2020) marked "P5065" confirms that they are likely of this pattern.

Many companies favoured these two piece insulators, and adopted them early on. It didn't take long before a myriad of sizes and variations in shape were created, as seen with the P3510 found on the EVSI&C Co. line. I hope this provides a bit of history; I have a lot more to write on deltas, but I will save that for their own article! ▲

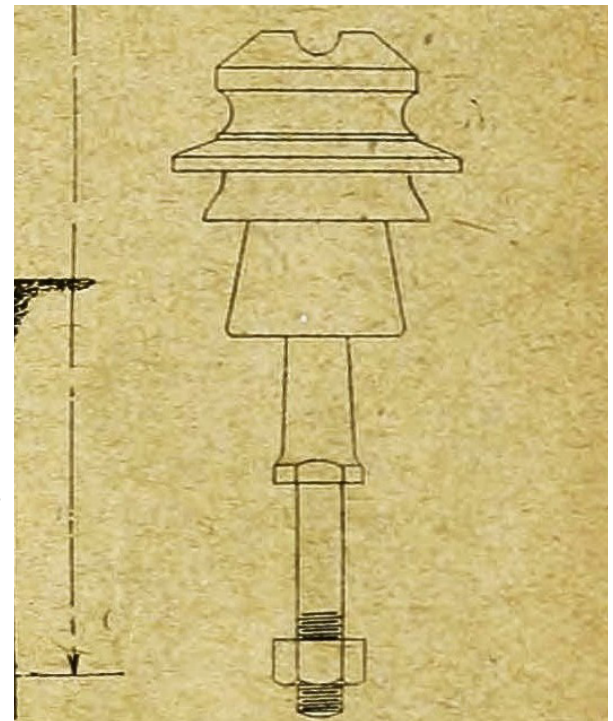

PICTURE D

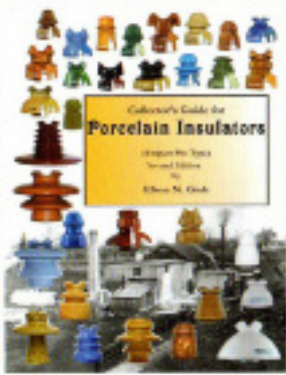

2019 – 2nd Edition Collector's Guide for
PORCELAIN INSULATORS
And
3rd Edition Value Guide

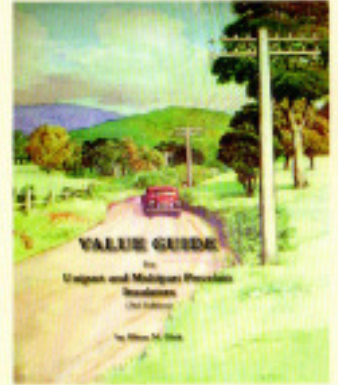

The 2019 2nd edition spiral bound 278-page **Guide Book** for the collector of Unipart porcelain insulators is in full color. There 21 new U-numbers for a total of 1028 styles of insulators shown in the U-Chart with **COLOR** photographs. Each photo has a cut-away to show the inner skirts and pinhole. The U-Chart has been simplified by eliminating most of the trimmer variants and catalog based styles

that do not accurately represent actual specimens. Manufacturer histories have been greatly expanded with nearly 500 historic and other photos and include details of 286 manufacturer's markings. Cost is \$45 plus \$5 shipping.

The spiral bound 126-page **Value Guide** is designed to be used with the new Guide Book. It lists manufacturer, marking, catalog number, color, rarity, and value for 4,354 unipart pin-types and 1201 multipart pin-types. 4 pages of color photos show various glaze colors and typical descriptions plus 2 color pages of odd glazes. 8 pages of new multipart styles are shown in color to update the 2nd edition book, Multipart Porcelain Insulators. Cost is \$29 plus \$4 ship. Both books can be ordered together for \$80. Personal check or money order accepted.

Personal check or money order accepted. Order from: Elton Gish, 5415 Lexington Circle, Lumberton, TX 77657

Order and pay with PayPal on website: www.r-infinity.com

Insulator Christmas Photo's

Let's see your Insulator Room Christmas Photo's (Doesn't have to be from this year and the Drip Points Staff will decide which one gets the Cover for the December Issue). or if you decorate your outside insulator display for the Holidays submit it as well. you can email them to the staff at drippoints@nia.org.

PLEASE HAVE PHOTO'S SUBMITTED NO LATER THAN NOVEMBER 1ST 2022



WANTED PORCELAIN INSULATORS

ONE PIECE OR A COLLECTION. I AM ALWAYS
LOOKING FOR BETTER PIECES OR GREAT COLOR
FOR MY COLLECTION. CASH OR TRADE.

MATT GRAYSON • NIA #387
mg3430@gmail.com • 718-507-5665

If you call, and I don't answer, I am probably traveling.
Email is always faster





UPCOMING EVENTS

OCTOBER 2022 - JUNE 2023

October 1, 2022 (Saturday)

MAYER, ARIZONA

The Grand Canyon Summer Meet and Show will be at 10090 S. Third Street, Mayer, AZ 86333. The show will run from 8am until done. All are welcome and any/all antiques can be sold/purchased or traded. Bring your own table and chair, lunch will be provided. Please RSVP to ensure we have enough food. For more details, contact Jim Harlow at 928 830-7716 or harlowmcl1@gmail.com

October 1, 2022 (Saturday)

MANCHESTER, CONNECTICUT

The Yankee Pole Cat Insulator Club Fall Swap Meet will be once again held at the Manchester Land Conservation Trust Bush Hill Farm property. The address is 330 Bush Hill Rd, Manchester, CT. We will be outdoors in the back lot - follow the driveway to the right of the barn. If you have collector friends that are not members of ICON please let them know about the swap. **ADMISSION IS FREE!** Since the club did not sponsor a summer swap to not to conflict with the National Insulator Association's "National" Show in Gettysburg, PA, this will be our only outdoor, informal get-together for 2022. Based on prior outdoor swaps, we anticipate many dealer tables as well a huge throng of eager collectors looking for goodies. Hours are 9-1. If you are planning on attending, **PLEASE DO NOT ARRIVE BEFORE 8.** There is no charge to set-up as many tables as you want; all tabletop collectibles are welcome. There are no tables on-site so please bring whatever table(s) and chair(s) you need. There is a port-o-potty on site adjacent to the barn by the main road. As a bonus this year, club members Doug MacGillvary and Tobey Sweet will be sponsoring a pizza lunch at noon! Thanks Doug and Tobey! I am sure they would accept a donation to offset their costs. Rain date is Saturday October 15. We all know that October 1 will be a fine, fall day. However, in the unlikely event of bad weather, the rain date is two Saturdays later Saturday October 15. If there is any doubt, please look for an email to ICON or check the Yankee Pole Cat Facebook page for last minute updates. If you have any questions about the event, please contact John Rajpolt: rajpolt@earthlink.net or 203-261-1190

October 1, 2022 (Saturday)

RIVER FALLS, WISCONSIN

The North Western Insulator Club Annual Fall Swap, Show and Sale will be in River Falls, Wisconsin hosted by Mike Braun. We are returning to the Glen Park Pavillion, an indoor facility surrounded by a large park. The building has a wall of garage type doors that can be opened for comfort and ventilation or closed if weather is inclement. There are floor to ceiling windows all around so the light for identifying colors is excellent. Tables and chairs are provided and lunch will be pot luck. Please bring a dish to share. A raffle will be held to finance current and future club activities. Donations will be welcomed. Contact Mike with donations or for any information. Time: 9:00 AM to 3:00 PM Host: Mike Braun. Phone: 651-999-9961 mbraun61@yahoo.com Location: Glen Park Pavilion, 361 W Park St. River Falls, Wisconsin Come ready to buy, trade and sell. Bring something to share for lunch. Bring an item to raffle to benefit the club. Be prepared for a great day with friends and fellow hobbyists!

October 1, 2022 (Saturday)

MILLBROOK, ONTARIO, CANADA

The Ontario Fall Backyard Insulator Show is back after a two year hiatus. The show will be held on Saturday, October 15th from 10 until 2 in Millbrook, Ontario. Location: 457 Ava Crescent, Millbrook Ontario (Cavan Monaghan Township) Contact: Chris Minicola (705) 932-1010 or (705) 875-3385 or cminicola@nexicomgroup.net Please bring your own table if you are planning on selling. Feel free to pass this along to any other collectors who might be interested. We'll have a pizza lunch at noon. Coffee, pop and water will be available too.

October 22, 2022 (Saturday)

GARLAND, TEXAS

The Garland Insulator and Collectibles Show will be held Saturday October 22, 2022 at the Springhill Suites by Marriott, 3251 E. George Bush Turnpike, Richardson Texas 75082, (972) 479-0300. Show hours are from 8:00 AM to 4:00 PM with free parking and free admission. Dealer tables are \$40.00 each with setup Friday night from 6:00 PM to 9:00 PM and Saturday morning from 6:00 AM to 8:00 AM. Contact show hosts Gary Fine (214) 546-9804 gfine102@aol.com or Mike Lyell (214) 681-0244 mikelyell@verizon.net for more information or to reserve a table.

November 4-6, 2022 (Friday-Sunday)

SPRINGFIELD, OHIO

52nd Mid-Ohio Insulator Show. Clark County Fairgrounds. 4401 South Charleston Pike. Exit 59 off I-70. Springfield, Ohio. Show Hours: Friday Noon - 6 PM Saturday 8 PM - 5 PM Sunday 9 AM - ??? 8-foot tables are \$ 45 each, display tables are always free with advance notification. For easy and immediate payment, PayPal customers can send payments directly to cboster530@att.net. For those wishing to pay via old timey methods, you can send a check or money order to Lois Blair. CONTACT: Curt Boster (614) 301-5125 cboster530@att.net

November 19, 2022 (Saturday)

EATONTON, GEORGIA

The Dixie Jewels Insulator Club's Fall Swap Meet will be held at the Lake Oconee Lutheran Church Community Center (formally the Harmony Community Center) located at 1081 Greensboro Rd., Eatonton, GA 31024. The center is located about 9 miles south of I-20, exit 130. Look for the Dixie Jewels Insulator sign outside the community center. Plenty of tables are available. Tables are free to club members or are available for a mere \$5.00 for non-members. A noon meal will be served. Please contact Dave Collins at dpc147@gmail.com for more information, or to reserve a table.

December 4, 2022 (Sunday)

ENFIELD, CONNECTICUT

The Yankee Pole Cat Insulator Club's Annual "Beat the Snow" Antique Insulator, Bottle & Collectibles Show will be Sunday December 4, 2022 at the American Legion Hall - Enfield, Connecticut. 566 Enfield Street (US Route 5) - Exit 49 off I-91 (just minutes South of Mass. Turnpike - I-90 Exit 4) Show Hours: 8:00 AM to 1:00 PM Insulators * Bottles * Jars * Lightning Rod Equipment * Flasks * Stoneware * Telephone & Telegraph Collectibles * Railroadiana Advertising & Paper Ephemera * Small Table Top Antiques **FREE ADMISSION** For Show Information, contact: John Rajpolt at 203-261-1190 or rajpolt@earthlink.net

April 1, 2023 (Saturday)

WHEATON, ILLINOIS

DuPage Collectors Expo Show will be held Saturday, April 1st, at the DuPage County Fairgrounds, 2015 Manchester Road, Wheaton, Illinois, Hours are 9:00 to 3:00. Items for sale & trade include: Insulators, Lightning Rod items & Weathervanes, Telephone & Telegraph items, Bottles, Jars, etc. Info: BOB STAHR: bob@hemingray.com (630) 793-5345 and RICK SOLLER: rdmer-shon@aol.com (847) 782-8602

UPCOMING EVENTS

JUNE 2023 - JULY 2024



June 9-11, 2023 (Friday-Sunday)

LOGAN, UTAH

The National Insulator Association's 54th Annual Show and Convention will be held at the Cache County Fairgrounds in Logan, Utah. The fairgrounds is located at 450 South 500 West, Logan, UT 84321. Logan is a small city in Cache Valley, a mountain valley located in the heart of the Rocky Mountains. It's an easy 90-minute drive from Salt Lake City's International Airport. The beautiful agricultural valley is nestled between two majestic mountain ranges and home to Utah State University. Logan is surrounded by several bedroom communities and is a slice of Americana that is like a step back in time. The pace is a little slower with many options for things to do. Attendees and their families can stay as busy or relaxed as they choose. Attendees can easily turn this show into a fantastic summer vacation. In addition to the multitude of things to do in the local area, Cache Valley is only 4 hours from Yellowstone & Teton National Parks and about 4 to 5 hours from most of Southern Utah's National Parks.



The show and all meetings will be held at the Cache County Fairgrounds Event Center, a relatively new facility completed in 2018. The building features a 20,000 square foot main hall with LED lighting and skylights for natural lighting. Adjacent smaller rooms will facilitate the Board meeting, Membership meeting, hospitality suites, etc. The building is air conditioned. There will be plenty of nearby parking. Loading and unloading will be at ground level.

The NIA Awards Banquet will be held at the Riverwoods Conference Center, 1.1 miles from the fairgrounds and between the Marriott Springhill Suites and Townplace Suites, our host hotels. There are several other hotels in similar proximity to the fairgrounds. There are RV accommodations at the fairgrounds with WiFi access. Uber, Lyft, taxi and free bus service are all available in the valley.

Full details can be found at https://www.nia.org/shows/2023_national/ or by contacting show hosts DON & JEANNE BRIEL, (435) 753-5786, Don.Briel@comcast.net and BRIAN & CATHY WEESE, (801) 201-5187, brianweese@gmail.com

June 28-30, 2024 (Friday-Sunday)

ELKHART, INDIANA

The 55th NIA National Show & Convention will be held at the Northern Indiana Events Center in Elkhart, Indiana. The Events Center is located at 21565 Executive Pkwy., Elkhart, IN 46514. Complete show information will be available in 2023 at the Logan Utah National and subsequently online. Show Hosts are: Kim Borgman, 317-698-9177

kim.borgman@mdc-usa.com, Gene Hawkins, 574-377-0171 gene.hawkins@mchsi.com, Arlen & Tina Rienstra, 219-226-4975 and Darryl Wagner, 816-719-0801 insulators@dwagnerkc.com.

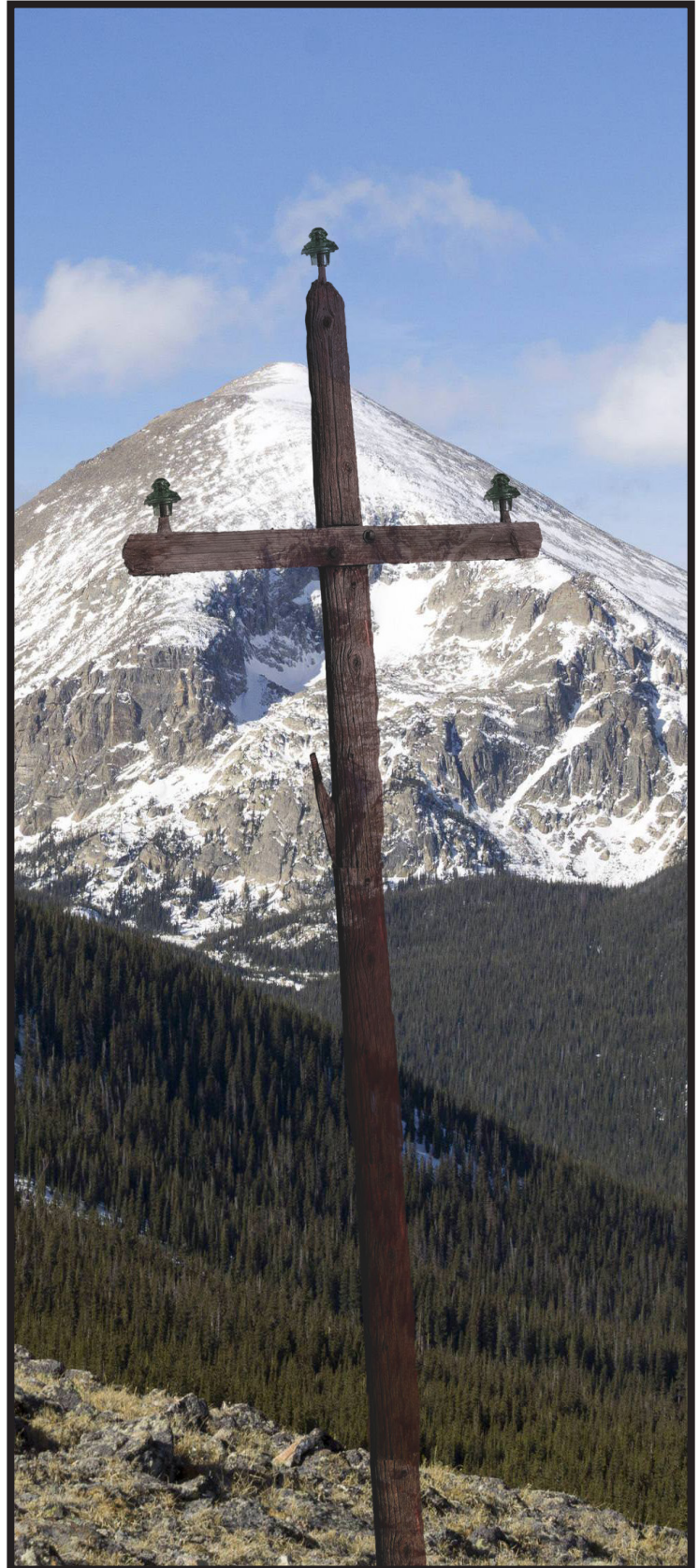

THE UPCOMING EVENTS LIST APPEARS COURTESY OF:

- The NIA Companion - <https://companion.nia.org>
- All Insulators - <https://allinsulators.com>

TO SUBMIT AN UPCOMING INSULATOR SHOW:

- <https://companion.nia.org/shows/>
- https://allinsulators.com/hobby/shows/submit_show/

NW Missouri Insulator And Bottle Show & Sale

March 11th, 2023 9:00 am to 3:00 pm



Dealer set up on Friday afternoon
Platte County Fairgrounds
15730 Fairgrounds Rd., Platte City, MO



85+ tables of Insulators, bottles, jars, telephones, lightning rod balls & arrows, advertising and other misc. antiques. Established show with a lot of advertising. Easy access from interstate. Great foot traffic from Kansas City, St. Joseph & surrounding rural areas.



FREE Insulator & bottle appraisal available
Display space available and displays welcome



Border States Antique Show & Sale

September 16th, 2023 9:00 am to 3:00 pm



Dealer set up on Friday afternoon
Douglas County Fairgrounds
2120 Harper St. Bldg. 21, Lawrence, KS



100+ tables of bottles, jars, insulators, postcards, advertising and other miscellaneous table-top antiques. Great venue in college town, 9500+ square foot of space with good lighting. Advertised in multiple papers and on-line. Lawrence sits between Kansas City, MO and Topeka, KS, so we have a good draw from metropolitan and rural areas.

FREE Insulator & bottle appraisal available
Display space available and displays welcome

For dealer and/or show information on either show

Contact Darryl Wagner

insulators@dwagnerkc.com

816-719-0801



Glass Insulator Collector

Dan Gauron

"Top prices paid for scare singles and whole collections"

P.O. Box 1721
Colorado Springs, CO 80901

719-492-0181
Alyeskaco@comcast.net

Buy - Sell - Trade

NIA #8176



Federation of Historical Bottle Collectors

History, Fun, Latest News, Digging, Finding, Early American Glass, Bottle & Glass Shows, Virtual Museum, People, Research, Auctions, Preserve Jars, Free-Blown Glass, Pattern Molded Glass, Blown Three Mold, Bitters, Medicines, Spirits, Foods & Sauces, Ink Bottles, Soda Pop, Historical Flasks, Spring & Mineral Water, Soda Water, Perfume & Cologne, Marbles, Fire Extinguishers, Target Balls, Lightning Rod Balls, Utility, Poisons, Merchandise, Lost & Found, Member Photos, Milks, Beer & Ale, Insulators, National Convention, Tableware, Hall of Fame, Online Seminars, Judged Displays, and a whole lot more...

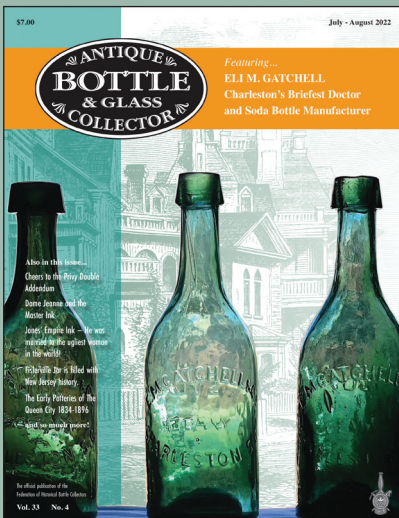
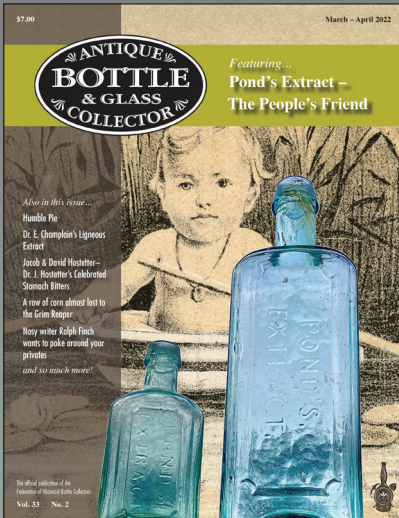

AVAILABLE NOW

AVAILABLE NOW

AVAILABLE NOW

545,520 February 2019 Hockley #108
215 "General Washington" And Bot "E. Parbur Unwin / TWD" And Eagle Portrait Flask, Kensington Glass Works, Philadelphia, Pennsylvania, 1765-1780; Reddish cobalt blue, threaded mouth - good condition, light exterior high year wear; 400-900; 10" South-South collection.

515,490 September 2020 Glass Works Auction #131
251 "General Washington" And Bot "E. Parbur Unwin / TWD" And Eagle Portrait Flask, Kensington Glass Works, Philadelphia, Pennsylvania, 1765-1780; "Firecracker" Reddish amber with a brown blue line, threaded mouth - good condition, light exterior high year wear; 400-14, 50; Gray and white Johnson collection.

Search Firecracker GI-14

FOHBC AUCTION PRICE REPORT

Now Available to FOHBC Members!

Online Auction Price Report. Search on your smartphone, tablet or desktop computer. Includes: 10 years of results from American Bottle Auctions, American Glass Gallery, Glass Works Auctions and Hockley in Price 1. The Auction Price Report will only be available to FOHBC members. Joining the FOHBC will give the new member 24/7/365 access. What a great tool this will be for the collectors, diggers, pickers, researchers and the generally curious!

Visit FOHBC.org Members Portal

Membership includes our bi-monthly 72-page plus covers magazine, **Antique Bottle & Glass Collector**, National Show VIP Access Rates, **FOHBC Virtual Museum Full Access Pass**, Bi-Monthly Newsletter, Access to online **FOHBC Auction Price Report**, Access to FOHBC website Members Portal for member list and archived historical information, free classified ad with membership and so much more!

FOHBC.org

FOHBCVirtualMuseum.org



ADVERTISEMENTS



*Looking To Add To Your Collection?
Check Out Our Fixed Price Listings & Auctions!*

The Insulator Store
www.TheInsulatorStore.com

PO Box 592 Fogelsville, PA 18051

sales@TheInsulatorStore.com

Buying Collections & Quality Singles - Will Travel The U.S. & Canada!



WANTED



Colorful Lightning Rod Insulators



Otis and Embossed LRI's



Terry Drollinger

509-830-2809

terrymdroll@yahoo.com





Eagle Cap Collectibles



Consign now for our next Auction

Howard Banks

www.EaglecapCollectibles.com

541-761-9456 hbanks@budget.net

Insulator Collectors Directory

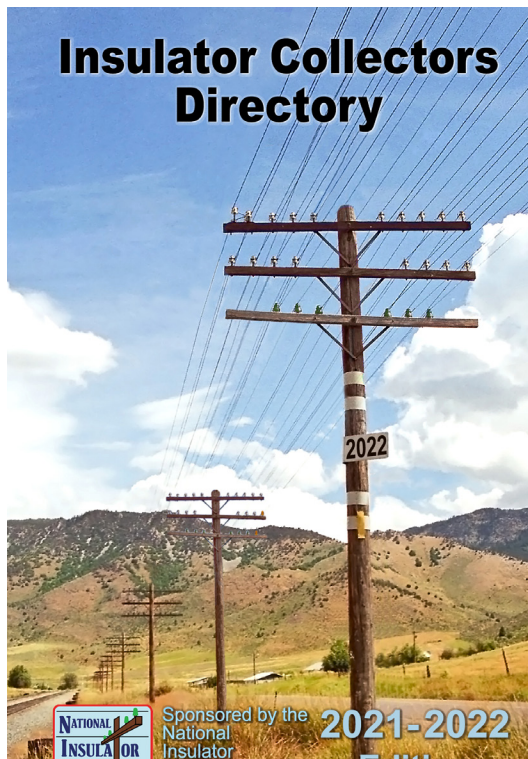

We are excited to release the new 2021-2022 printed Insulator Collectors Directory.

This full-color handy reference can help you find other collectors in a specific area, find a mentor, find other collectors with specific interests, etc. Both online and printed versions are available.

We have shipped all of the pre-orders, but a limited number of extra copies were printed and are now available for \$15 postage paid to NIA members. Don't delay — these are sure to go quickly.

You can order yours online at:

<https://insulatorcollectors.org/purchase>

or through NIA Products (order form is included in this magazine).



National Insulator Association Scholarship Fund

**Attention young insulator collectors-
this scholarship is for you!**

Money for college \$1000/\$500 up to \$2000

Write a 300 word essay telling us how to spread the word about the hobby.

Go to <http://www.nia.org/scholarship>



Submission deadline is March 1

The Scholarship Application and Application Guide is available at:

<http://www.nia.org/scholarship/>



Collect Railroad Antiques?

Since 1971, the Railroadiana Collectors Association Inc. has strived to educate and preserve the history of dining car china/silver, lanterns, porcelain signs, railroad art, timetables, locks and keys, builders plates, and all railroad related memorabilia. Join for \$42.00 per year (\$120 for 3 yrs.) to receive our full-color quarterly publication and connect with railroad antique collectors around the world. Email us for a free electronic copy of our current edition.

www.railroadcollectors.org/membership | joinRCAI@gmail.com

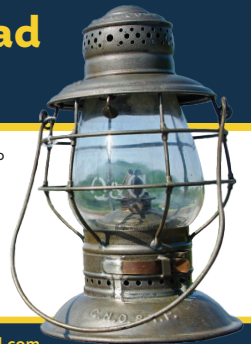

Hemingray Glass Co.

INSULATOR SPECIALIST • NIA #5185



CHRISTIAN E. WILLIS
mr.hemingray@gmail.com
www.hemingray.info
(949) 338-1404



ALL INSULATORS

Crown Jewels of the Wire

The official magazine for Insulator collectors since 1969



For more than 50 years Crown Jewels of the Wire has been the leading publication for glass and porcelain insulator hobby news, history, articles with columns devoted to worldwide insulators, show reports, in-depth research articles, meeting announcements, photos and other insulator information. There is something for everyone who enjoys insulators!

Being a quarterly publication allows the contributors to create some amazingly rich, well-researched articles. It is like getting a new book on insulators four times a year.

Some of the topics regularly covered are:

- Threadless insulators
- Porcelain insulators
- Insulators from around the world
- North American glass insulators
- Lightning rod insulators
- Research on historic lines
- Hunts and finds
- Upcoming insulator show information

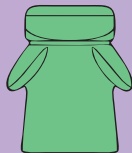

NIA members discount!

All NIA Members get a \$3 discount when subscribing or renewing. If paying by mail, just include the coupon you received with your NIA membership and make check out for \$3 less. If renewing/subscribing online, email shaun@allinsulators.com for directions.

Subscription options

Print (USA)	\$45
Print (Canada)	\$60
Electronic	\$30
Print & Electronic (USA)	\$60
Print & Electronic (Canada)	\$75

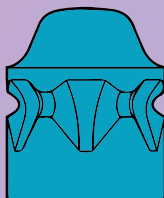

Subscribe online

You can subscribe online by credit card or PayPal at: <https://allinsulators.com/magazine/>

Subscribe by mail

Make checks payable to:
Hemingray Glass Company
Send to:
Hemingray Glass Co
P.O. Box 210145
Auburn Hills, MI 48321



DRIP POINTS Advertising Information

Help support the NIA's Drip Points by advertising. New rates below include discounts for multiple runs. We now offer classified rates also.

# of Issues	Covers*	Full Page (8" x 10")	1/2 Page (8" x 4.5" or 4.5" x 10")	1/4 Page (4.5" x 3.9" or 8" x 2.1")	1/8 Page (3.9" x 2.1" or 2.2" x 4.5")	1/16 Page (2.2" x 1.8")
1 Issue	\$135	\$90	\$50	\$30	\$18	\$12
2 Issues	\$257	\$171	\$95	\$57	\$34	\$23
3 Issues	\$379	\$252	\$140	\$84	\$50	\$34
4 Issues	\$497	\$331	\$184	\$110	\$66	\$44
5 Issues	\$614	\$410	\$228	\$137	\$82	\$55
6 Issues	\$729	\$486	\$270	\$162	\$97	\$65

* Back Cover (8.5"x8.5") Inside Back Cover & Inside Front Cover (8.5"x11")

Classified Ads:
10 cents per word, **15 cents per bold word**, \$2.50 min./per Issue

Size: _____ #Issues: _____ Cost per Issue: _____ Total cost: _____

Size: _____ #Issues: _____ Cost per Issue: _____ Total cost: _____

Size: _____ #Issues: _____ Cost per Issue: _____ Total cost: _____

Please supply camera ready artwork; preferred file formats include: PDF, TIF, JPG, DOC, DOCX.

Ads can be designed for an additional fee (please contact Doug Rusher at admanager@nia.org).

To receive the multi-issue discount, ads must run in consecutive issues with no changes.

Ads must be pre-paid. We accept PayPal (treasurer@nia.org) or checks payable to the NIA.

Ads must meet all postal regulations that govern publications mailed at Non-Profit Standard Mail postage rate.

Name: _____

Address: _____

City, St, zip: _____

Phone: _____

Email: _____

To place an ad, send form with payment to:

Doug Rusher

3370 Chance Ct.

Helena, MT 59602 admanager@nia.org

DRIP POINTS Publishing Schedule

Issue	#	Deadline	Mailing
February	1	Jan. 10	Feb. 1
April	2	Mar. 10	Apr. 1
June	3	May 10	Jun. 1
August	4	Jul. 10	Aug. 1
October	5	Sep. 10	Oct. 1
December	6	Nov. 10	Dec. 1



CURRENT (2019) EDITION

North American Glass Insulators – Identification, Reference, & Price Guide

- New CDs & CD Changes
- New Index Listings
- Added Color Listings
- Unverified Questionable Listings Removed
- New and Updated Appendices
- Updated Prices
- 14,500+ listings
- 388 pages – 6” x 9”
- Spiral Bound

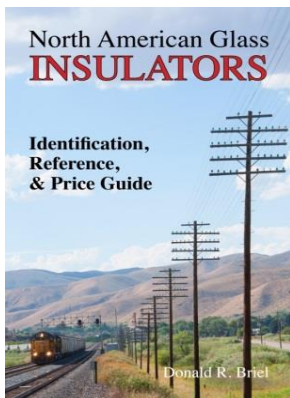

Paper Edition -- \$49 ppd* in U.S.

Paper Edition w/Price Guide Browser -- \$79 ppd* in U.S.

*** For delivery outside of the U.S. please contact Don Briel for current shipping cost and payment instructions**

Access Price Guide information on your phone or computer
Visit: www.PriceGuideBrowser.com for a demonstration of the Price Guide Browser produced by Bill Meier

To order, visit: www.InsulatorPriceGuide.com or mail a check or money order to:

Donald R. Briel

P. O. Box 188 • Providence, Utah 84332

Contact: Don.Briel@comcast.net or (435) 753-5786

Now Buying and Selling Insulators

as well as Trades Considered

ZnZ Ventures

Roger & Beth Ziesak

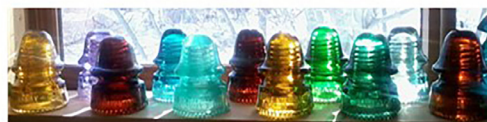

From single insulators to collections of all sizes.
Glass or porcelain, tell us what you've got
or let us know what you're looking for.
Also dealing in Railroadiana and Collectable Coins.

406-239-1646

Ziesakventures@gmail.com

WANTED: Insulator collections big and small! Midwest collector will travel far and wide to make offers and give appraisals. I will pay TOP DOLLAR for yours! Please contact Andy Wadysz, 734-735-8376, awadysz@hotmail.com

**WANTED CD206
"CASTLE"
in GREEN in Mint
Condition**



**Spencer Garten
7087 Saddle Creek Lane
Sarasota FL 34241**

**PH 859-351-2617 (Call or Text)
Spencer.Garten@gmail.com**



**FREE NIA MEMBER
CLASSIFIEDS**

**WANTED: M-2636 IN TURQUOISE, CASH OR TRADE CONTACT
ROGER OR BETH AT 406-239-1646**

ZAC MIRECKI: Collector seeks better: Tolls, Hi Tops, Foreign, GPCo, Hartford Faience, medicine bottles, and stamps. Email for want list. Zac Mirecki (860) 916-9014 zacharymirecki@protonmail.com

SEND IN YOUR FREE 25-WORD AD TO DRIPPOINTS@NIA.ORG.



DONATE TO THE NIA

A REQUEST FROM THE NIA DEVELOPMENT COMMITTEE

Dear Fellow Collector,

The NIA is a 501(c)3 nonprofit organization and as such, gifts may be tax deductible. Gifts of support will help the Association improve existing benefits and services as well as create new benefits and services for members and those collectors who are yet to become members. Your gift will allow the NIA to continue its mission to encourage growth and public awareness of the insulator hobby through collecting, dealing and educational endeavors. The NIA has identified four areas where donations will help create and enhance programs directed to that mission:

SCHOLARSHIP FUND: Currently the NIA can grant up to two scholarships totaling \$2,000.00 each year. Additional funding would give additional funds for future years; scholarship grants could be increased; or additional scholarships could be granted each year.

EDUCATIONAL RESOURCE DEVELOPMENT: There are projects that have been suggested but haven't been implemented for lack of funding such as the production of classroom video presentations, NIA traveling displays for use by learning facilities such as libraries, schools, museums and a Speakers Bureau. These are just a few of the new ideas for greater community awareness of our hobby.

NATIONAL & REGIONAL SHOW SUPPORT: The NIA has assumed a financial supportive role intended to assist National Show Hosts/Organizers in reducing their financial risk. With your donations the NIA could possibly increase advertising and promotional reimbursements, possibly provide all awards at National/Regional Shows and possibly provide financial assistance for Regional Shows.

INTERNET TECHNOLOGY: The desire for instant communication and information retrieval is with us and cannot be denied. For the association and the hobby to continue to grow it must have a strong presence on the Internet and social media. Donations in this area can help redesign the NIA web site, create videos for posting on social media, develop and present "live" shows including interviews, auctions and sales.

Amount of Donation		Donation Level	Donation Area (circle one)
\$ 0.00 -	\$ 49.99	Aqua	Scholarship Fund
\$ 50.00 -	\$ 99.99	Green	
\$ 100.00 -	\$ 249.99	Emerald	Educational Development
\$ 250.00 -	\$ 499.99	Carnival	
\$ 500.00 -	\$ 999.99	Amber	National & Regional Shows
\$ 1,000.00 -	\$ 2,499.99	Peacock	
\$ 2,500.00 -	\$ 4,999.99	Purple	Internet Technology
\$ 5,000.00 -	\$ 9,999.99	Cobalt	
\$ 10,000.00+		Hobby Benefactor	General Fund

Other Donation area: _____ Amount \$ _____

Amount Enclosed: _____ **Signature:** _____ **Date:** _____

Additional Information: _____ **If it is OK to list you as a donor, check here:**

Name: _____ Date: _____

Address: _____ Phone: _____

City: _____ State: _____ Zip: _____

Email Address: _____

All donors will be listed on the NIA website and any donors of \$50.00 or more will be listed in Drip Points.

Please mail form and payment (payable to NIA) to: NIA Treasurer, Bill Rohde, P.O. Box 28, Colusa, CA 95932

For additional information regarding gifts to the National Insulator Association, Inc., please contact the NIA Development Committee, E-mail address: donations@nia.org. Your gift is deductible, to the fullest extent of the law. The National Insulator Association (www.nia.org) is a 501(c)(3) non-profit organization.

Thank you for your support of the NIA!



THANK YOU FOR YOUR SUPPORT!

2022 NIA Donors & Sponsors

The NIA would like to acknowledge this year's Donors & Sponsors

Name	From	Level	Additional Information
Tommy Bolack	New Mexico	Hobby Benefactor	Drip Points
Anonymous	California	Amber	2022 National
Robert Tucker	Missouri	Amber	Scholarship
George Snow	Utah	Carnival	General Fund
Dan Gauron	Colorado	Carnival	General Fund
Connie Dueker	Colorado	Emerald	Museum Display
Howard Huckle	New York	Emerald	General Fund
Bill Sagatis	New York	Emerald	General Fund
Anonymous	Kansas	Emerald	General Fund
Anonymous	Michigan	Emerald	General Fund
Anonymous	Maryland	Emerald	General Fund

Thank you for your support!

The list above is compiled from multiple sources and may not be complete. If you have donated this year, but don't see your name (unless you wanted to be anonymous), please contact the development committee chairman.



Of NIA Membership

- Elton Gish NIA#41
- Sherry Lu Krell NIA#252
- Doug MacGillvary NIA#259
- Richard "Rick" Baldwin NIA#336
- John De Sousa NIA#419
- Darrell Karlin NIA#440
- Joseph "Joe" Beres NIA#563
- Richard "Dick" Bowman NIA#597





NIA AFFILIATED CLUBS

THE FOLLOWING INSULATOR CLUBS ARE MEMBERS OF THE NIA



Central Florida Insulator Club
Jacque Linscott Barnes
3557 Nicklaus Drive
Titusville, FL 32780-5356
321-480-1800
bluebellwt@aol.com



Chesapeake Bay Insulator Club
Larry Novak
12604 Eldrid Court
Silver Spring, MD 20904
301-680-8910
cbic@clubs.insulators.info



Dixie Jewels Insulator Club
Bill Haley
215 McFarland Ave.
Chattanooga, TN 37405
423-756-4106
djjic@clubs.insulators.info



Greater Chicago Insulator Club
Bob Stahr
360 S. Kenilworth Ave.
Glen Ellyn, IL 60137
630-793-5345
gcic@clubs.insulators.info



Golden State Insulator Club
Bob McLaughlin
2327 E. Goshen Ave.
Fresno, CA 93720
559-790-0194
rdmclau@comcast.net



Huron Valley Bottle & Insulator Club
Rod Krupka
2641 Echo Lane
Ortonville, MI 48462
248-627-6351
rod.krupka@yahoo.com



Insulator Collectors On the Net
Bill Meier
103 Canterbury Court
Carlisle, MA 01741-1860
978-369-0208
icon@clubs.insulators.info



Lone Star Insulator Club
Chris Renaudo
15707 Brookforest Dr.
Houston, TX 77059
lsic@clubs.insulators.info



Missouri Valley Insulator Club
Darryl Wagner
14615 NW Skyview Ave
Smithville, MO 64089
816-719-0801
mvic@clubs.insulators.info



North Western Insulator Club
Colin Yennie
504 White Birch CT NW
Oronoco, MN 55960 2030
507-289-1095
nwic@clubs.insulators.info



Triple Ridge Insulator Club
Dan Gauron
P.O. Box 1721
Colorado Springs, CO 80901
719-266-0181
danielgauron@yahoo.com



Western Reserve Insulator Club
John Hovanec
13009 Ridge Road
North Royalton, OH 44133
440-237-2242
wric@clubs.insulators.info



Yankee Pole Cat Insulator Club
John Rajpolt
17 Pheasant Lane
Monroe, CT 06468
203-261-1190
ypcic@clubs.insulators.info

Do you represent a local insulator club or other related organization? Become an NIA Affiliated Club today! See next page to apply for or renew your membership.



NIA MEMBERSHIP & RENEWAL FORM

Prospective members may join the NIA at any time; however, the "membership year" begins on January 1st and ends on December 31st. New memberships issued within four months of the beginning of the new membership year (September – December) will be good for the following calendar year. New members are entitled to all membership privileges immediately upon acceptance by the NIA. **If you are joining the NIA during the months of January through August, your membership will expire on December 31st of this Calendar year.**

Join or renew on-line at www.nia.org/membership

or submit to:

Andrew Gibson

5997 Springwater Rd.
Dansville, NY 14437-9772

membership@nia.org

Please Print Legibly

Check class of membership:

- | | |
|---|--|
| <input type="checkbox"/> Family Electronic Drip Points..... \$35.00 | <input type="checkbox"/> Canadian Electronic Drip Points.....\$35.00 |
| <input type="checkbox"/> Family Printed Drip Points..... \$58.00 | <input type="checkbox"/> Canadian Printed Drip Points..... \$75.00 |
| <input type="checkbox"/> Family Both Options of DP \$65.00 | <input type="checkbox"/> Canadian Both Options of DP..... \$82.00 |
| <input type="checkbox"/> Junior Both Options of DP..... \$10.00 | <input type="checkbox"/> Other Countries Electronic DP.....\$35.00 |
| <input type="checkbox"/> Club Electronic Drip Points..... \$50.00 | <input type="checkbox"/> Other Countries Printed DP..... \$78.00 |
| <input type="checkbox"/> Club Printed Drip Points..... \$70.00 | <input type="checkbox"/> Other Countries Both DP..... \$85.00 |

Name _____
 NIA # (if renewal) _____
 Address _____
 City _____
 State/Province _____
 Zip/Postal Code _____ (+4) _____
 Country (if not U.S.) _____
 Telephone Number _____
 E-Mail Address _____

Additional Family Members residing in the same household at no additional cost.

(e.g.: spouse, minor children or dependents)

Name	NIA # (if renewal)
1 _____	_____
2 _____	_____
3 _____	_____
4 _____	_____
5 _____	_____

(An e-mail address is required for electronic version of Drip Points)

Include me in NIA Hobby Directory: On-Line: Yes No
 Include my USPS Address in: On-Line: Yes No
 Include my Email Address in: On-Line: Yes No
 Include my Telephone Number in: On-Line: Yes No

Printed: Yes No
 Printed: Yes No
 Printed: Yes No
 Printed: Yes No

Fees to be submitted

You may purchase the current 2023 printed Hobby Directory for \$14.00 Yes (limited availability) Donation Amount.....
 You may pre-purchase the 2024 printed Hobby Directory for \$12.00..... Yes **If it is OK to list you as a donor check here:**

Signed _____ Date _____ Total Enclosed \$ _____
 How did you hear about the NIA _____ **Make Checks Payable to the NIA**

NIA MEMBERSHIP BENEFITS

Revised September 18, 2022

Connect to a worldwide network of over 1000 insulator collectors sharing information, history and the latest news on insulator collecting.

Receive electronic notification of upcoming events and current activity in your region of the country through the bi-monthly electronic distribution of the Drip Points Magazine (Also available in printed form).

Receive members only access to an enormous digital library of insulator catalogs, patents and insulator manufacturer history.

Find and meet other NIA members in your area for mentorship, visit & share collections and swap stories in person or on the NIA Facebook page.

Receive guaranteed early exclusive access to NIA National Shows to display, buy and sell insulators.

Compete for National Awards and Recognition for your displays, research and contributions to the hobby.

Start your own insulator reference library with the "NIA Resource Page", "Fake and Altered Insulators" and "What is an Insulator?"

Advertise your hobby passion through your complimentary NIA Decal, Membership Bars, Membership Card and free ad in Drip Points.

Use your membership to run for the National Insulator Association Board of Directors to shape the future of the hobby.

Contribute to a National Scholarship Program and financial support for NIA Show Hosts in your local area.

Continue membership to sustain these benefits and help raise the next generation of insulator collectors through your knowledge & engagement.

Note: The NIA Member Handbook is available on the NIA website (www.nia.org/membership/index.htm).
 Hard copies of the Handbook are available upon request to the NIA Membership Director (membership@nia.org).



MERCHANDISE

SHOW YOUR SUPPORT WITH CLOTHING, BADGES & MORE

Christmas will be upon us before we know it, so if you have someone that would like an NIA Logo product, order early. Also don't forget that if there is an item or color that we don't have listed, you can request a special order at any time.



Embroidered Logo T-Shirts

Hanes Adult T-Shirt, Embroidered logo on front

Colors: Smoke, Smoky Graphite, Sky Blue, Electric Blue, Aqua, Dark Cobalt, Lt Brown Amber, Med Amber, Rootbeer Amber, Lt Olive Green, 7 Up Green, Dark Olive Green, Yellow, Golden Amber, Oxblood, Deep Red Amber

Price: \$19 (S-XL) \$23 (2X-3X)

Color(s): _____ Size: _____ Qty: _____

Shirt Sizing Chart	
S 32-34	XL 44-46
M 36-38	2X 48-50
L 40-42	3X 52-54

Special Orders: If you don't see a size or color that you'd like, contact us for availability and price.

NEW ITEM 3 button polo's. We have 6 colors: Smokey Graphite, Cobalt, 7 Up, Yellow, Golden Amber & Flashed Amber. They are priced at \$28 for (S-XL) & \$30 for (2X)



3 Button Polo, Color _____
Size _____ Qty: _____



Screen Printed T-Shirts

Colors: Smoke, Smoky Graphite, Steel Blue, Peacock Blue, Dark Cobalt, Lt Brown Amber, Med Amber, Olive Amber, Rootbeer Amber, Apple Green, 7-Up Green, Olive Green, Yellow, Golden Amber, Flashed Amber, Oxblood

Price: \$19 (S-XL) \$23 (2X-3X)



Gildan Adult T-Shirt - Small logo on front, large logo on back
Color(s): _____ Size: _____ Qty: _____



Button Down Shirt

Port Authority SanMar Blend, embroidered logo on front

Colors: Dark Smoke, Aqua, Cobalt, Lt Brown Amber, Yellow, Flashed Amber

Price:
Short Sleeve: \$34 (S-XL) \$37 (2X)
Long Sleeve: \$36 (S-XL) \$39 (2X)

Short or Long Sleeve: _____

Color(s): _____ Size: _____ Qty: _____



Hooded Sweatshirt

Gildan Adult Full-Zip Hooded Sweatshirt, embroidered logo on front

Colors: Medium Smoke, Cobalt

Price: \$35 (S-XL) \$39 (2X)

Color(s): _____ Size: _____ Qty: _____



Denim Button Down Shirt

Sierra Pacific, Short or Long Sleeve

Color: Aqua

Price:
Short Sleeve: \$36 (S-XL) \$40 (2X-3X)
Long Sleeve: \$39 (S-XL) \$43 (2X-3X)

Short or Long Sleeve: _____ Size: _____ Qty: _____



Crew Neck Sweatshirt

Gildan Adult Crewneck Sweatshirt, Screen print with small logo on front & large logo on back

Color: Smoke
Price: \$29 (S-XL) \$33 (2X)

Size: _____ Qty: _____



Un-Structured

Embroidered Caps

Colors (Un-Structured):

Smoke, Dark Smoke, Aqua, Cobalt, Lt Brown Amber, 7 Up Green, Olive Green, Yellow, Gold Amber, Flashed Amber, Pink, Oxblood

Colors (Structured with Mesh):

Khaki-Brown, Royal-White, Kelly-White, Red-White, Heather-Gray-Black, Royal, Cardinal, Gray-Charcoal-Black, White-Royal, Khaki-White



Structured with Mesh

Un-Structured Price: \$15.00 **Mesh:** \$17.00 **Cap Type:** _____ **Color(s):** _____ **Qty:** _____

1 Insulator Caliper

Measures up to 7"
Plastic will not scratch insulators
Long outside & short inside jaws
Price: \$18 **Qty:** _____

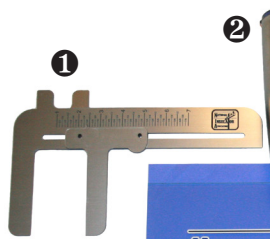

2 20 oz. Copper-Lined Stainless Steel Tumbler

Yeti-like Stainless tumbler keeps drinks cold or hot for hours!
One color imprint (blue)
SOLD OUT

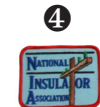

3 16 oz. Travel Tumbler

4 color imprint
Price: \$14 **\$10** **Qty:** _____

On Sale!

4 NIA Collector's Patch

2 3/4" x 3 3/4" embroidered patch
Price: \$4 **Qty:** _____

5 NIA Window Decal (Color)

For outside car window - 4 1/4 x 5 3/4
Price: \$7 **Qty:** _____

6 NIA Window Decal (White)

For outside car window - 5 1/2 x 6 3/4
Price: \$10 **Qty:** _____

7 NIA Challenge Coin

2019; 50 Years of Meets & Shows; 2 sided
Price: \$10 **Qty:** _____

8 NIA Hat/Lapel Pin

Price: \$7 **Qty:** _____

9 NIA Name Badge Engraved; beveled edges; Magnetic back **Price:** \$18

Name Badge Engraving Information:

Name _____ NIA# _____ City _____ State _____
Name _____ NIA# _____ City _____ State _____
Name _____ NIA# _____ City _____ State _____

10 Badge Bar NIA or Club position, Club Bars, Show Bars, Awards or Custom Bars **Price:** \$5

Badge Bar Engraving Information:

Club Bar _____ Qty: _____ Line 1 _____
Show Bar _____ Year _____ Line 2 _____

Insulator Collectors Hobby Directory - 2021/2022 Hobby wide directory to locate other collectors in your area or around the world **Price:** \$15 (shipping included) **Qty:** _____



Tote Bags

Sturdy with white screen print NIA logo - Dimensions: 12 1/2" W x 13 1/2" H x 8 1/2" D; 14" handles

Colors: Sapphire, Light Brown Amber, Cobalt, Oxblood, Black
Price: \$8
Color(s): _____ **Qty:** _____

Contiguous U.S. Postage Rates:

- \$10.00 for the first item of clothing, hat, tumbler, tote or caliper & \$3.50 for each additional item in same group.
- Patches & Badge Bars \$1.00 ea.
- Decals, Name Badges, Hat Pins, Challenge Coins..... \$4.00 ea.
- If patches, badge bars, decals, name badges, hat pins & challenge coins are ordered with clothing, there is no additional postage for these items.
- For postage outside the Contiguous U.S., please contact us for a quote.

Subtotal: \$ _____

U.S. Postage: \$ _____

Total Enclosed: \$ _____

Please make check or money order payable in U.S. funds to the National Insulator Association.

Name: _____

Address: _____

City: _____ State: _____ Zip: _____

Phone: _____

Email: _____

Please send detached, completed form and payment to:
Margaret Wagner, 14615 Skyview Ave., Smithville, MO 64089
(816) 719-0802 • niaproducts@nia.org

NIA Board of Directors

President

Darryl Wagner – NIA #8671
14615 NW Skyview Ave.
Smithville, MO 64089
president@nia.org

First Past President

Steve Roberts – NIA #7935
2404 Mansker Dr.
Madison, TN 37115
1stpastpres@nia.org

Western Region VP

Roger Ziesak – NIA #8919
8865 Grouse Dr.
Missoula, MT 59808
westernvp@nia.org

Central Region VP

Chris Hedges – NIA #15
621 W. 61st St.
Kansas City, MO 64113
centralvp@nia.org

Eastern Region VP

Gus Stafford – NIA #8871
816 Flintlock Ridge Rd.
Mechanicsburg, PA 17055
easternvp@nia.org

Secretary

Carolyn Berry – NIA #4336
1010 Wren Ct.
Round Rock, TX 78681
secretary@nia.org

Treasurer

Bill Rohde – NIA #1219
P.O. Box 28
Colusa, CA 95932
treasurer@nia.org

Membership Director

Andrew Gibson – NIA #2422
5997 Springwater Rd.
Dansville, NY 14437-9772
membership@nia.org

Information Director

Spencer Garten, NIA #10044
7087 Saddle Creek Ln
Sarasota, FL 34241
information@nia.org

NIA Advisors & Committee Chairs

Ad Manager

Doug Rusher – NIA #1773
3370 Chance Ct.
Helena, MT 59602
admanager@nia.org

Authentication & Classification Advisor

Paul Greaves – NIA #2685
8830 Benton Acre Rd.
Granite Bay, CA 95746
authentication@nia.org

Awards & Recognition Chair

Ken Willick – NIA #3709
7349 Seneca Ave.
Lima, NY 14485
awards@nia.org

Commemorative Coordinator

Margaret Wagner – NIA #8711
14615 Skyview Ave.
Smithville, MO 64089
commemorative@nia.org

Development Committee Chair

Bill Rohde – NIA #1219
P.O. Box 28
Colusa, CA 95932
donations@nia.org

Directory Committee Chair

Nathan Holmes – NIA #4002
6570 Pawnee Cir.
Colorado Springs, CO 80920
directory@nia.org

Drip Points Managing Editor

Doug Rusher – NIA #1773
3370 Chance Ct.
Helena, MT 59602
drippoints@nia.org

Ethics Advisor

Daryl Stahler – NIA #8843
4622 N. Paseo Pitiquito
Tucson, AZ 85750
ethics@nia.org

Events Committee Chair

Gene Hawkins – NIA #421
3847 N. Prairie St.
Warsaw, IN 46582
show@nia.org

Finance Committee Chair

Bill Snell – NIA #2624
11427 E. Scarritt Ave.
Sugar Creek, MO 64054
finance@nia.org

Historian

Rick Soller – NIA #2958
4086 Blackstone Ave.
Gurnee, IL 60031
historian@nia.org

Product Manager

Margaret Wagner – NIA #8711
14615 NW Skyview Ave.
Smithville, MO 64089
niaproducts@nia.org

Promotions Committee Chair

Spencer Garten, NIA #10044
7087 Saddle Creek Ln
Sarasota, FL 34241
promotions@nia.org

Research & Education Advisor

Lee Brewer – NIA #6695
344 S. Main St.
Bellefontaine, OH 43311
education@nia.org

Rules & Procedures Advisor

Don Briel – NIA #7218
P.O. Box 188
Providence, UT 84332
procedures@nia.org

Scholarship Committee Chair

Tammy Brewer – NIA #6696
344 S. Main St.
Bellefontaine, OH 43311
scholarship@nia.org

Webmaster, Technology Committee Chair

Bob Berry – NIA #1203
1010 Wren Ct.
Round Rock, TX 78681
webmaster@nia.org

Drip Points Editorial Staff

Doug Rusher – *Managing Editor*

Nathan Holmes – *Assistant Editor*

Mike Green – *Assistant Editor*

Christian Willis – *Assistant Editor*

International Article Coordinator

Mike Doyle – NIA #5932
1805 East Country Ct.
Visalia, CA 93292
international@nia.org

Drip Points Show Report Coordinator

Connie Dueker
2560 Oak Hills Drive
Colorado Springs, CO 80919
showreports@nia.org



Bill and Jill Insulators

www.billandjillinsulators.com

info@billandjillinsulators.com

Bill and Jill Meier • 103 Canterbury Ct
Carlisle, MA 01741 • 781-999-3048

Go with the best!

But don't take our word for it...

Facebook 5.0 (24 votes)

Google 5.0 (10 reviews)



**Watch for our upcoming
auctions!**

We're always accepting consignments



National Insulator Association
 10801 N. 24th Ave. Ste. 103
 Phoenix, AZ 85029-4712



DARIO DIMARE

FREE APPRAISALS

DARIO@DARIODESIGNS.COM

COLLECTING INSULATORS SINCE 1967!

WILL BUY ONE PIECE OR AN ENTIRE COLLECTION

318 MAIN STREET, NORTHBOROUGH, MA 01532

DARIO DIMARE

CONSIGNMENTS ACCEPTED

617-306-2420